



OLTEX TRADING

LOOKBOOK



Oltex Trading has a team of professionals driven by innovation and improvement, who collaborate by sharing skills and knowledge in order to create an unbeatable value for the customer. In addition, we are committed to a close and personal treatment, offering a complete advice.

Our collections are studied with the aim of achieving excellence in all aspects. The selection of raw materials, dyes, finishes and quality controls, give shape to the best Premium Blanks in the market.

Committed to sustainability, we offer an ecological logistics service, with a fast delivery service, as well as exceptional assistance to control the status of your orders.



T-SHIRTS

Long Sintra	12-13
Mundaka	14-15
Sarek	16-17
Sierra Nevada	18-19
Sintra	20-21
Texel	22-23
Veleta	24-25

POLOS

Banff	28-29
Es Trenc	30-31
Göreme	32-33
Göreme Plain	34-35

CREWNECKS

Crewneck Etna	38-39
Crewneck Hudson	40-41
Crewneck Porto	42-43
Olunka	44-45
Olunka Medium	46-47
Timanfaya	48-49

HOODIES-ZIPPERS

Dolomitas	52-53
Hoodie Etna	54-55
Etna Supreme	56-57
Hoodie Porto	58-59
Hoodie Hudson	60-61
Lagos	62-63
Hoodie Peniche	64-65
Teide	66-67
Yellowstone	68-69
Zipper Porto	70-71

HALF ZIPS

Alaska	74-75
Durmitor	76-77
Half Zip Peniche	78-79
Malibu	80-81
Zion	82-83

BOTTOMS

Ericeira	86-87
Jogger Peniche	88-89
Jogger Porto	90-91

SHIRTS

Formentera	94-95
Menorca	96-97

COLOUR

Colour Palette	99-104
Colour Equivalences	106



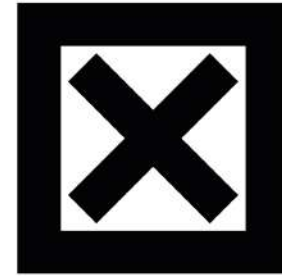

OLTEx
t r a d i n g

PREMIUM QUALITY

Unisex

T-shirts



LONG SINTRA
TSU038

- 100% Cotton
- 240 GSM
- Oversized
- S - 2XL



SINTRA
TSU018

- 100% Cotton
- 240 GSM
- Oversized
- S - 2XL



MUNDAKA
TSU029

- 100% Organic Cotton
- 210 GSM
- Oversized
- S - 2XL



TEXEL
TSU0001

- 100% Organic Cotton
- 185 GSM
- Medium fit
- S - 4XL



SAREK
TSU0002

- 100% Organic Cotton
- 185 GSM
- Oversized
- S - 2XL



VELETA
TSU019

- 100% Organic Cotton
- 185 GSM
- Oversized
- S - 2XL
- Vintage



SIERRA NEVADA
TSU0003

- 100% Organic Cotton
- 185 GSM
- Oversized
- S - 2XL
- Vintage





LONG SINTRA

TSU038

Single Jersey
100% Cotton
240 GSM

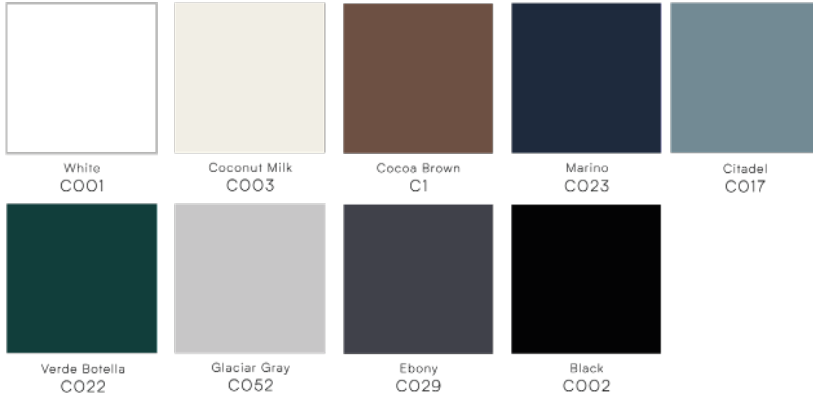

Specifications

Wide 1x1 rib at neck collar and sleeve cuff with single topstitch
Inside back neck tape in self fabric
Dropped shoulder

LONG SINTRA

TSU038

| Unisex

| Oversized

| S - 2XL

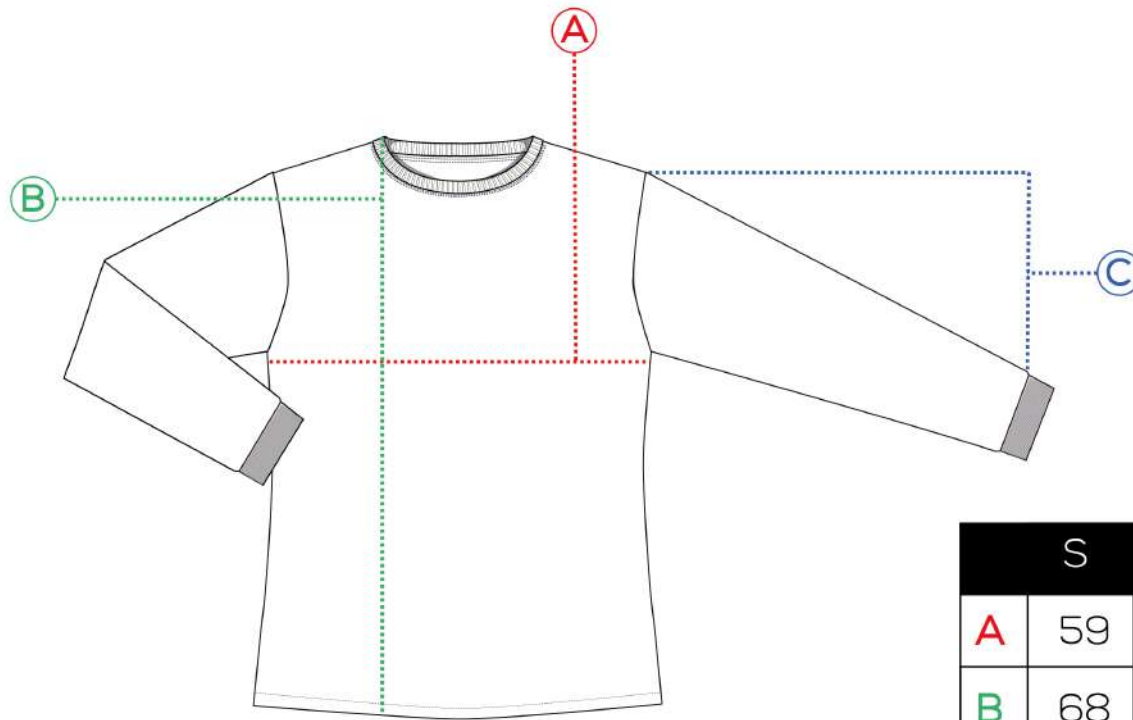

	S	M	L	XL	XXL
A	59	61	63	65	67
B	68	70	72	74	76
C	59	60	61	62	63

cm

MUNDAKA

TSU029

Single Jersey
100% Organic Cotton
210 GSM

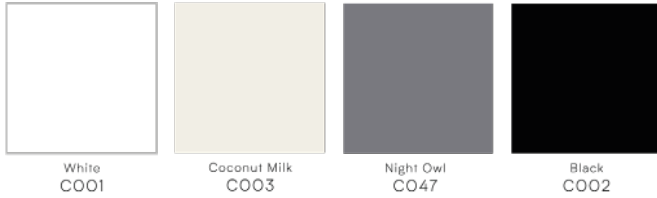

Specifications

1x1 rib at neck collar with single topstitch
Inside back neck tape in self fabric
Bottom hem and sleeve hem with wide double needle topstitch
Dropped shoulder



MUNDAKA

TSU029

| Unisex

| Oversized

| S - 2XL

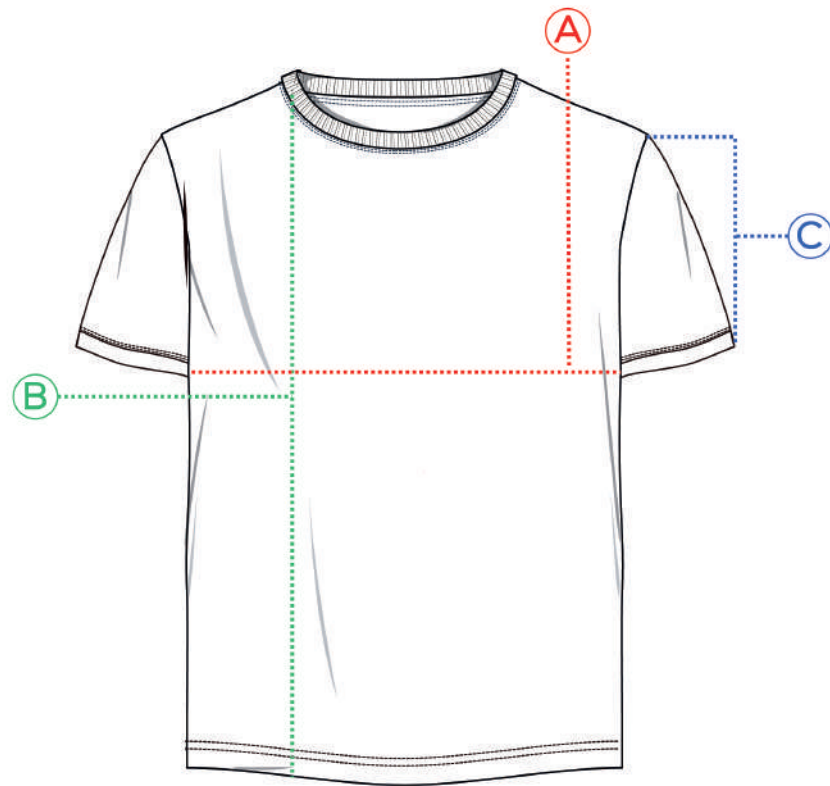

	S	M	L	XL	XXL
A	63	66	70	74	81
B	67,5	70,5	74,5	77	81
C	12,5	14,5	16	18	19

cm

SAREK

TSU0002

Single Jersey
100% Organic Cotton
185 GSM



Specifications

1x1 rib at neck collar with single topstitch

Inside back neck tape in self fabric

Bottom hem and sleeve hem with wide double needle topstitch



SAREK

TSU0002

| Unisex

| Oversized

| S - 2XL

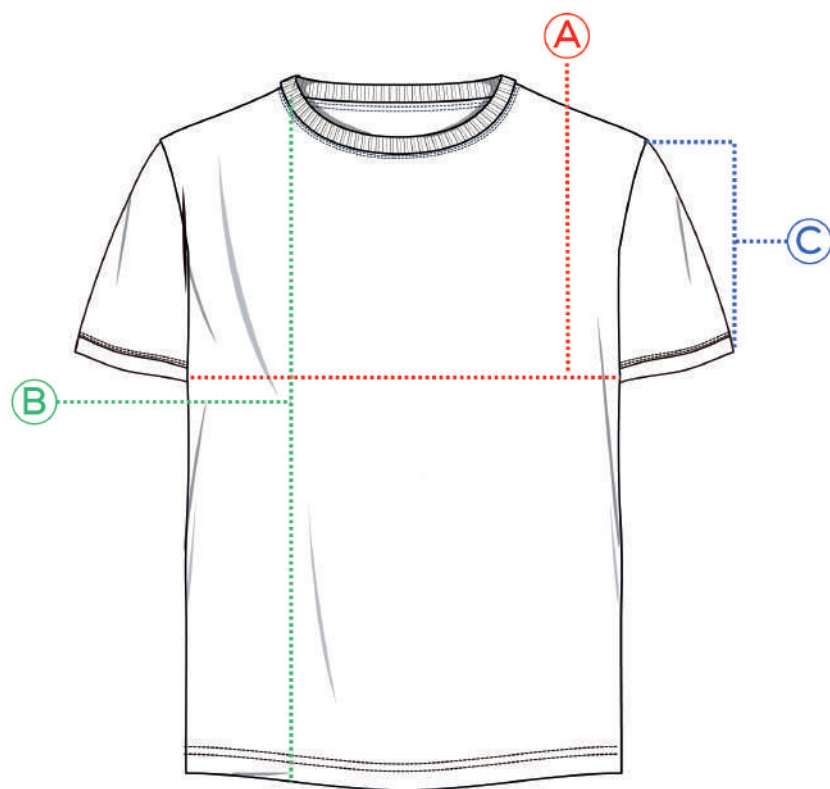

	S	M	L	XL	XXL
A	53	57	60	64	68
B	69	73	75	77	80
C	24	25	26	27	28

cm

SIERRA NEVADA

TSU0003

Single Jersey
100% Organic Cotton
185 GSM
Vintage

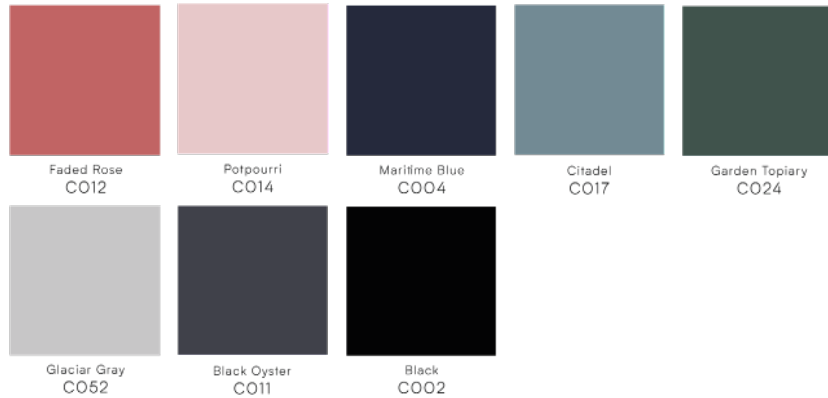

Specifications

1x1 rib at neck collar with single topstitch
Inside back neck tape in self fabric
Bottom hem and sleeve hem with wide double needle topstitch
Stone Wash



SIERRA NEVADA

TSU0003

| Unisex

| Oversized

| S - 2XL

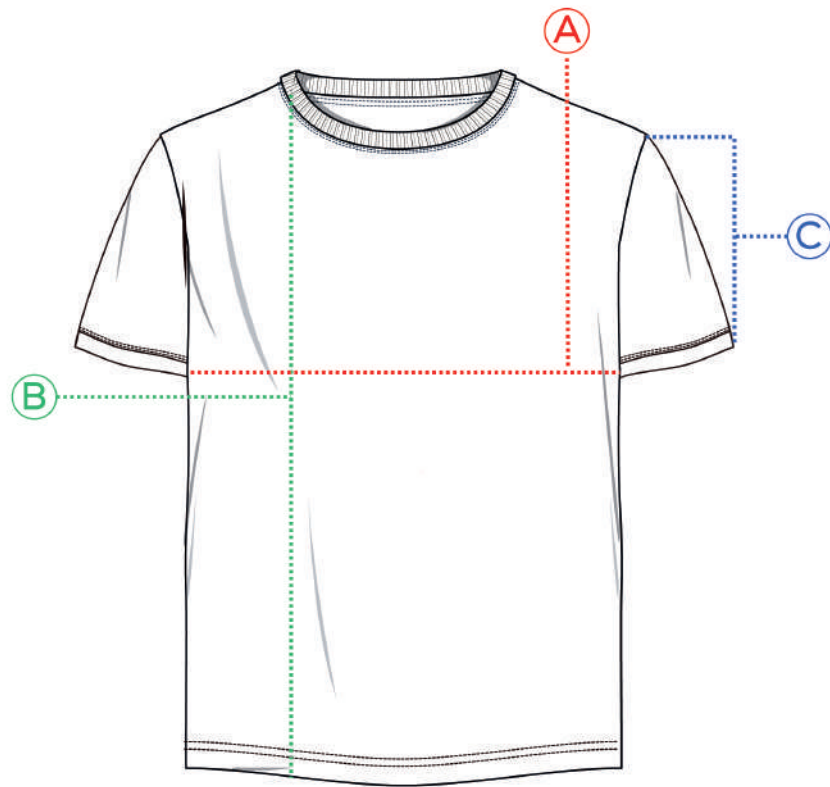

	S	M	L	XL	XXL
A	53	57	60	64	68
B	69	73	75	77	80
C	24	25	26	27	28

cm

SINTRA

TSU018

Single Jersey
100% Cotton
240 GSM

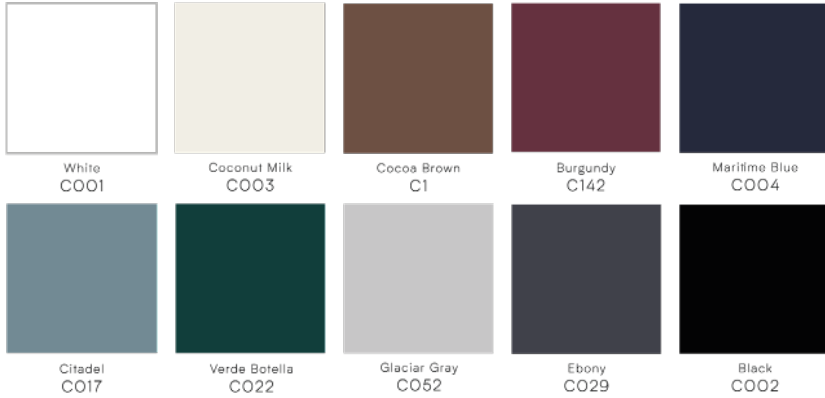

Specifications

Wide 1x1 rib at neck collar with single topstitch
Inside back neck tape in self fabric
Bottom hem and sleeve hem with wide double needle topstitch
Dropped shoulder

SINTRA

TSU018

| Unisex

| Oversized

| S - 2XL

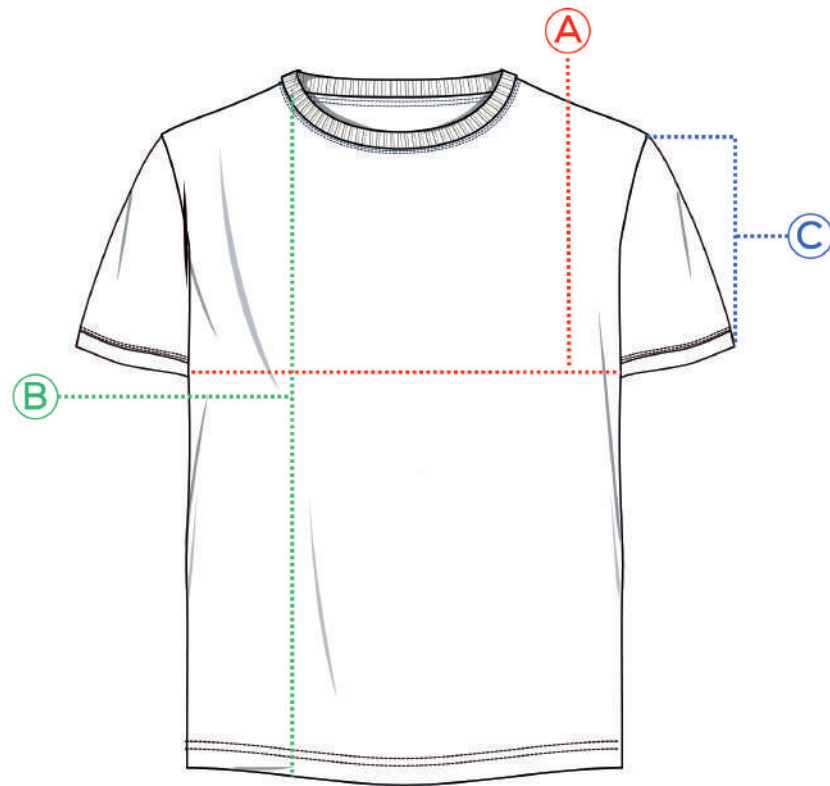

	S	M	L	XL	XXL
A	55	60	65	70	75
B	72	76	79	83	86
C	20	21	22	23	24

cm

TEXEL

TSU0001

Single Jersey
100% Organic Cotton
185 GSM



Specifications

- 1x1 rib at neck collar
- Inside back neck tape in self fabric
- Bottom hem and sleeve hem with wide double needle topstitch
- Set-in sleeve



TEXEL

TSU0001

| Unisex

| Medium fit

| S - 4XL

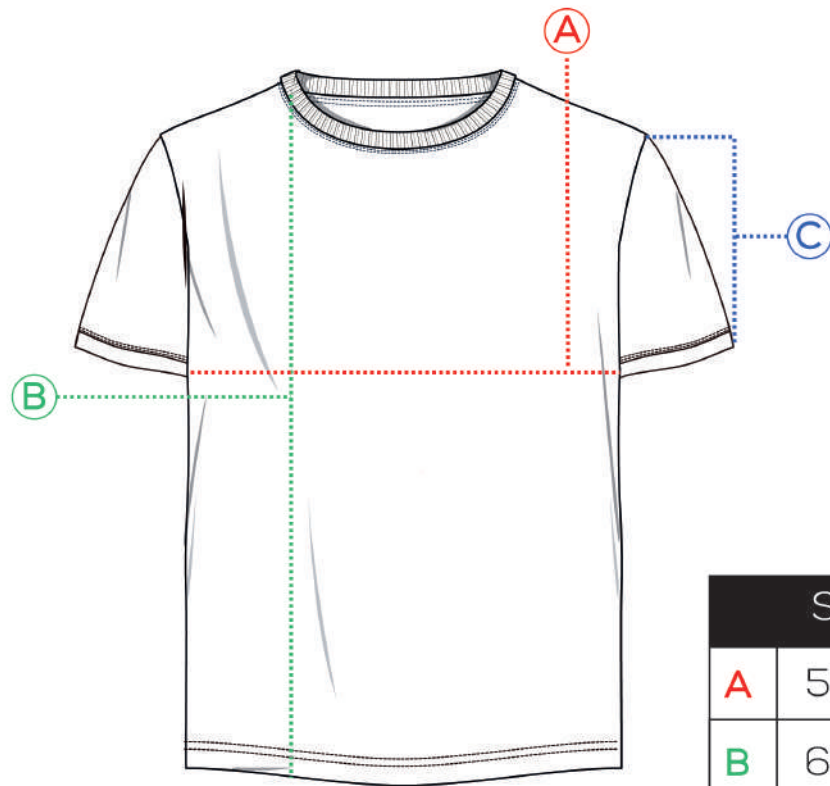

	S	M	L	XL	XXL	3XL	4XL
A	50	52	54	56	58	60	62
B	69	71	73	75	77	79	81
C	21	22	23	24	25	26	27

cm

VELETA

TSU019

Single Jersey
100% Organic Cotton
185 GSM
Vintage

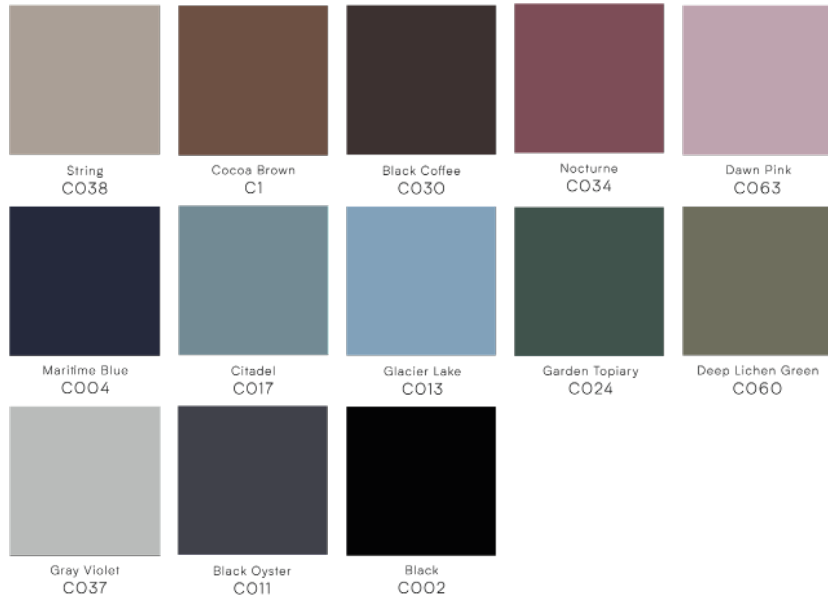

Specifications

1x1 rib at neck collar with single topstitch
Inside back neck tape in self fabric
Bottom hem and sleeve hem with wide double needle topstitch
Stone Wash



VELETA

TSU019

| Unisex

| Oversized

| S - 2XL

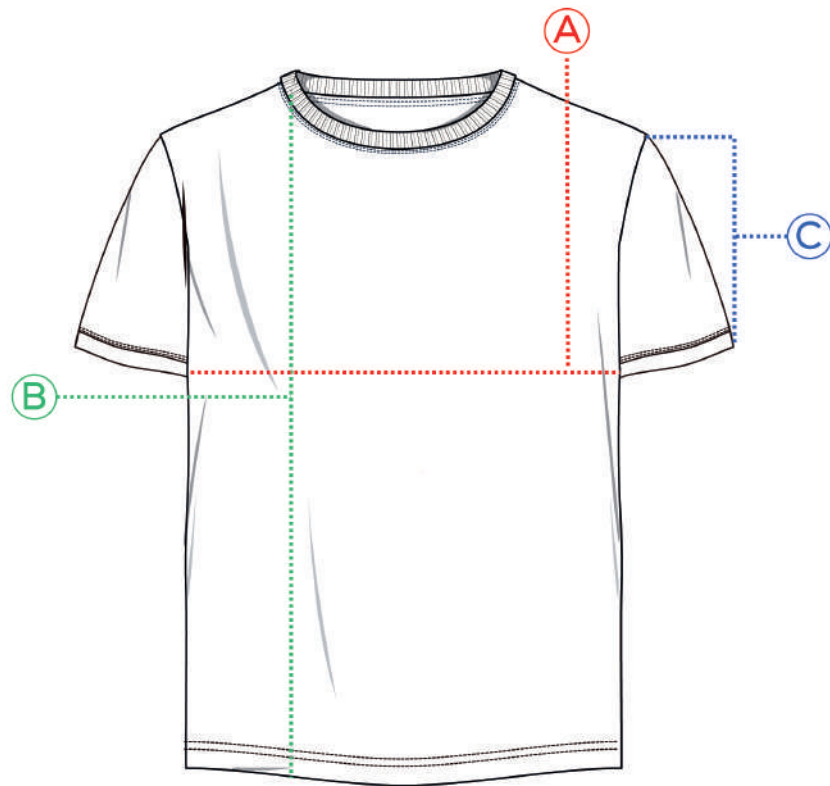

	S	M	L	XL	XXL
A	53	57	60	64	68
B	69	73	75	77	80
C	24	25	26	27	28

cm

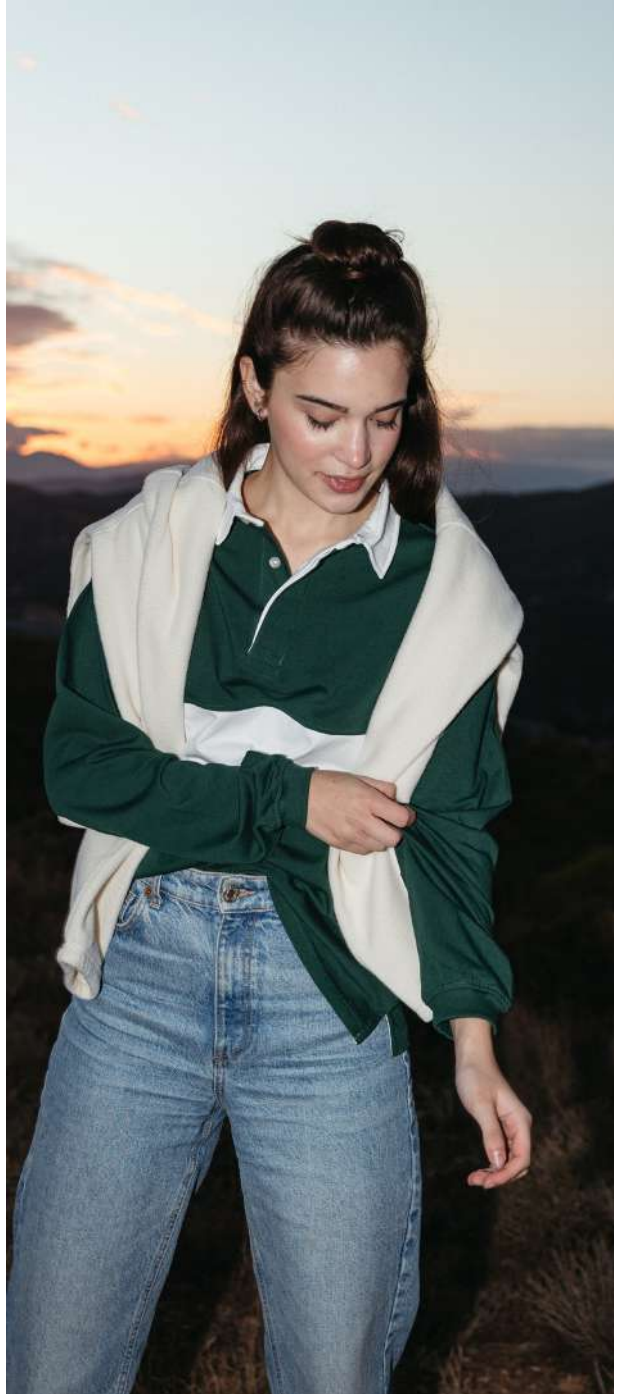



Unisex

Polos

BANFF POLU030

- 100% Organic Cotton ■
- 220 GSM ■
- Medium fit ■
- S - 3XL ■



ES TRENC POLU031

- 100% Organic Cotton ■
- 220 GSM ■
- Medium fit ■
- S - 3XL ■
- Vintage ■



GÖREME POLU0009

- 100% Cotton ■
- 240 GSM ■
- Oversized ■
- S - 2XL ■



GÖREME PLAIN POLU040

- 100% Cotton ■
- 240 GSM ■
- Oversized ■
- S - 2XL ■



BANFF

POLU030

Piqué
100% Organic Cotton
220 GSM

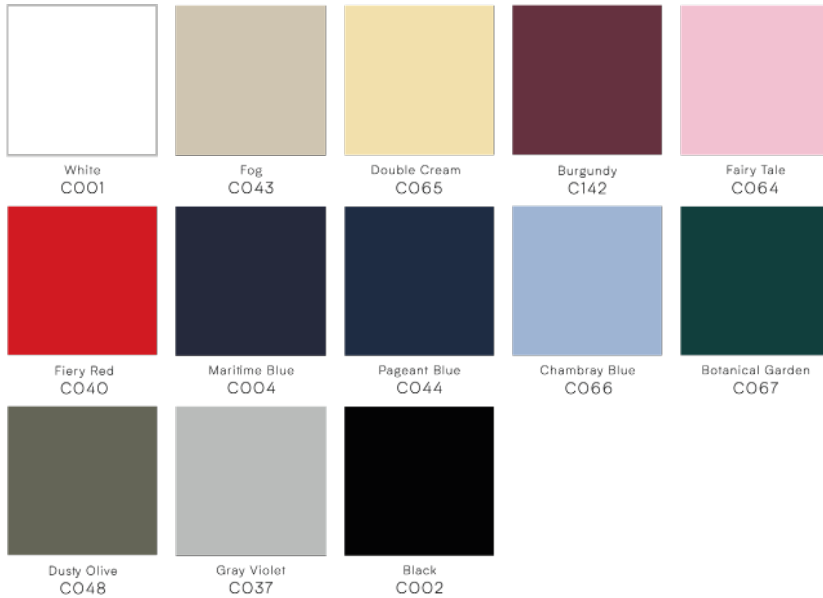

Specifications

Front placket with 2 white buttons
Flat knit rib on collar and sleeve hem
Inside herringbone back neck tape
Self fabric half moon at back neck
Slit at side seams with heavy herringbone facing
Set-in sleeve



BANFF

POLU030

| Unisex

| Medium fit

| S - 3XL

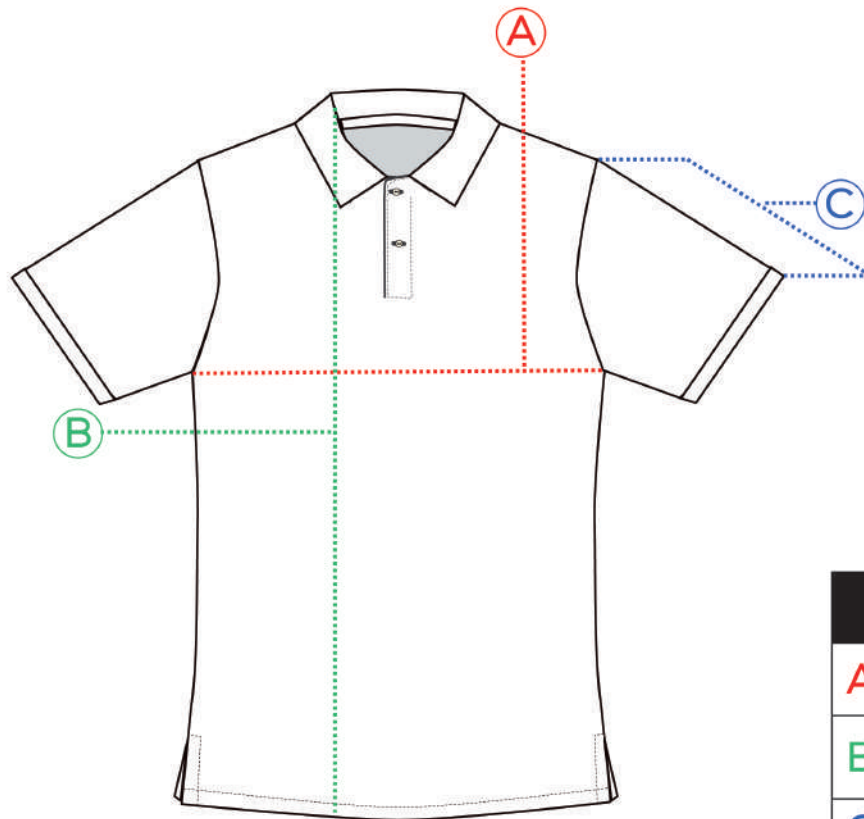

	S	M	L	XL	XXL	
A	52	54	56	58	60	62
B	71	73	75	77	79	81
C	21	21,5	22	22,5	23	23,5

cm

ES TRENC

POLU031

Piqué
100% Organic Cotton
220 GSM
Vintage

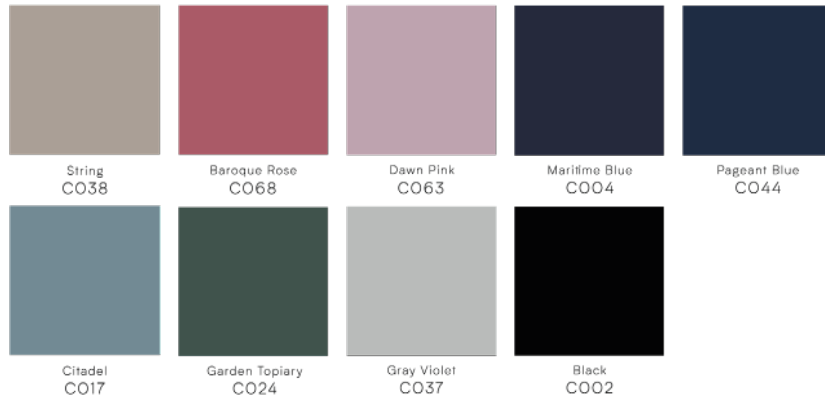

Specifications

- Front placket with 2 white buttons
- Flat knit rib on collar and sleeve hem
- Inside herringbone back neck tape
- Self fabric half moon at back neck
- Slit at side seams with heavy herringbone facing
- Set-in sleeve
- Stone Wash



ES TRENC

POLU031

| Unisex

| Medium fit

| S - 3XL

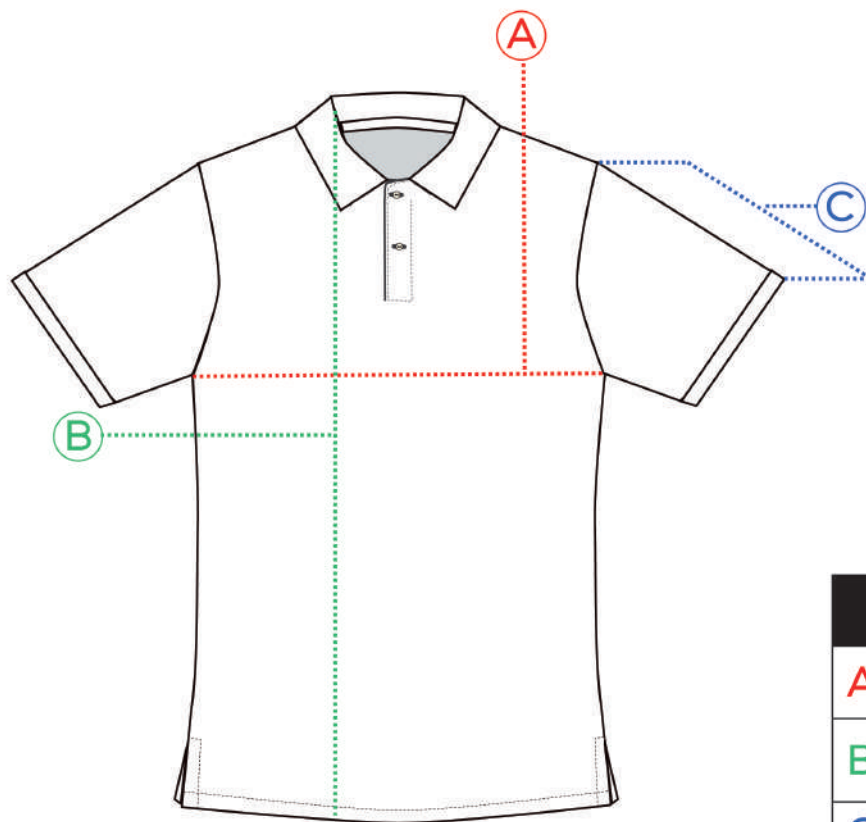

	S	M	L	XL	XXL	
A	52	54	56	58	60	62
B	71	73	75	77	79	81
C	21	21,5	22	22,5	23	23,5

cm

GÖREME

POLU0009

Single Jersey
100% Cotton
240 GSM



Coconut Milk
CO03



Coconut Milk
CO03



Maritime Blue
CO04



Garden Topiary
CO24



Specifications

- White single jersey collar
- Self fabric half moon at back neck
- Front placket with 3 white buttons
- Front strip of different color
- 1x1 rib at sleeve cuff
- Slit at side seams with heavy herringbone facing
- Dropped shoulder

GÖREME

POLU0009

| Unisex

| Oversized

| S - 2XL

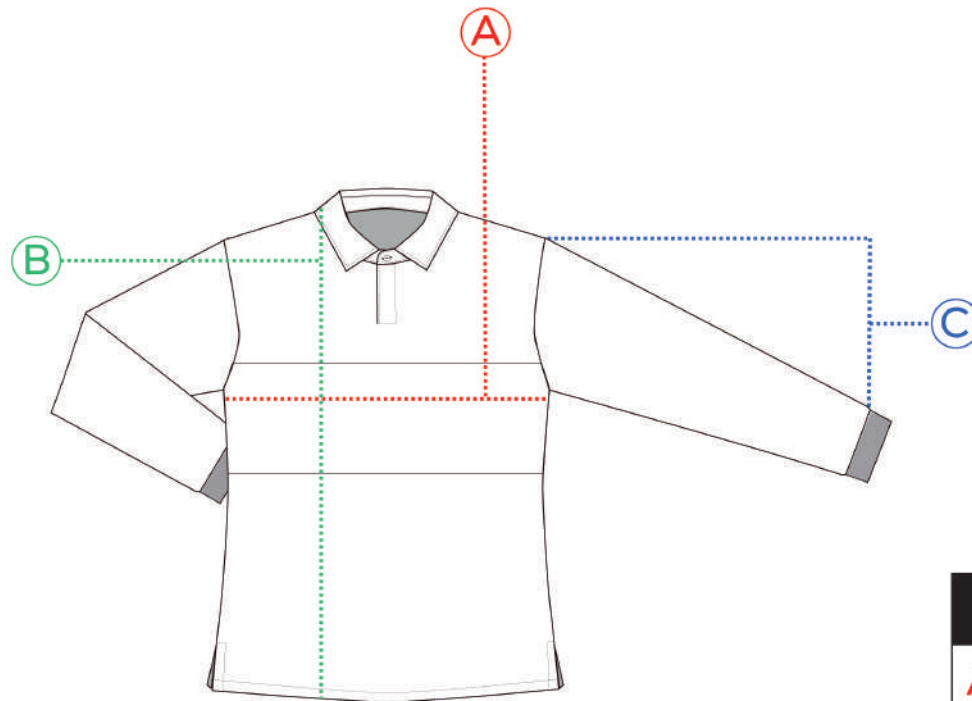

	S	M	L	XL	XXL
A	59	61	63	65	67
B	68	70	72	74	76
C	59	60	61	62	63

cm

GÖREME PLAIN

POLU040

Single Jersey
100% Cotton
240 GSM

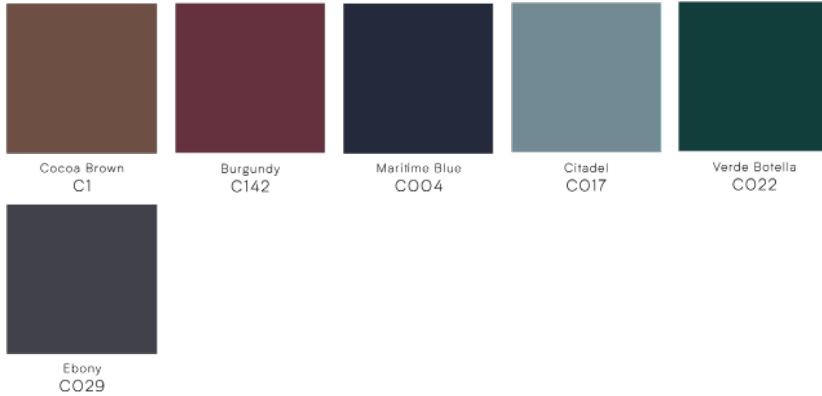

Specifications

White single jersey collar
Self fabric half moon at back neck
Front placket with 3 white buttons
1x1 rib at sleeve cuff
Slit at side seams with heavy herringbone facing
Dropped shoulder

GÖREME PLAIN

POLU040

| Unisex

| Oversized

| S - 2XL

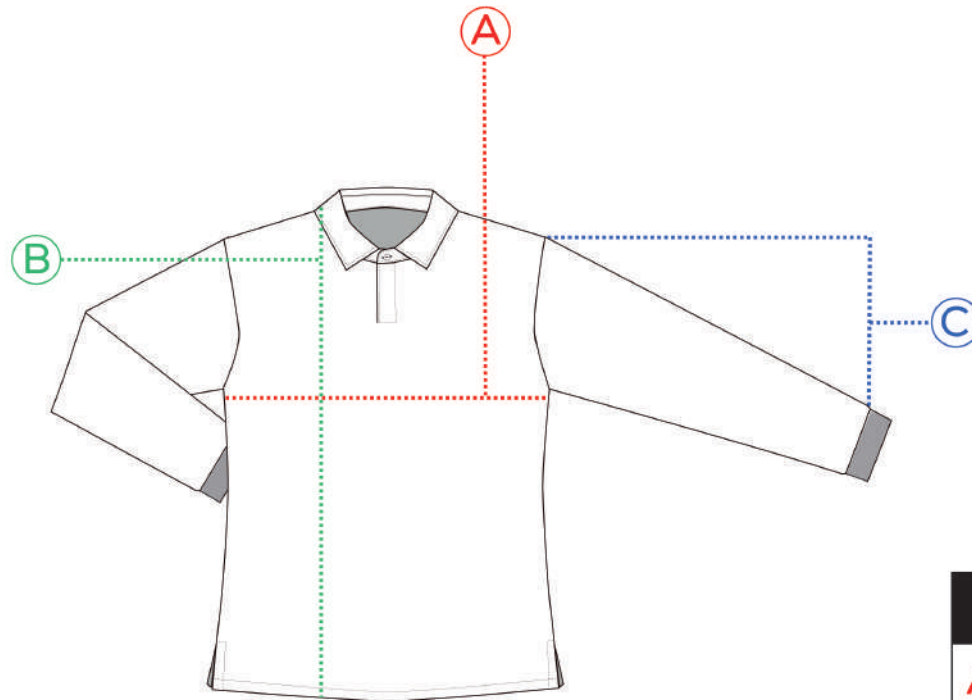

	S	M	L	XL	XXL
A	59	61	63	65	67
B	68	70	72	74	76
C	59	60	61	62	63

cm

Unisex

CREWNECKS



CREWNECK ETNA
CRU0012

- 100% Organic Cotton
- 380 GSM
- Oversized
- S - 2XL



OLUNKA MEDIUM
CRU022

- 100% Organic Cotton
- 320 GSM
- Medium fit
- S - 2XL



CREWNECK HUDSON
CRU0013

- 100% Organic Cotton
- 350 GSM
- Oversized
- S - 2XL
- Vintage



TIMANFAYA
CRU0008

- 100% Cotton
- 320 GSM
- Medium fit
- S - 3XL
- Carbon effect



CREWNECK PORTO
CRU033

- 100% Cotton
- 420 GSM
- Oversized
- S - 2XL



OLUNKA
CRU0007

- 100% Organic Cotton
- 320 GSM
- Fitted
- S - 2XL





CREWNECK ETNA

CRU0012

Terry Sweatshirt
100% Organic Cotton
380 GSM

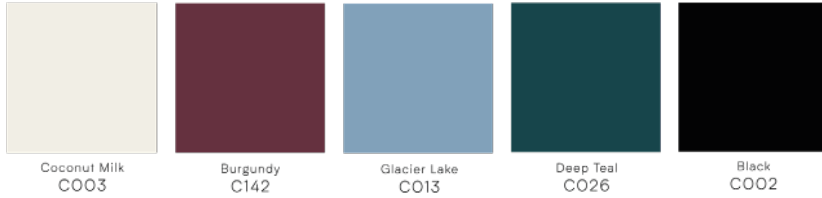

Specifications

1x1 rib at neck collar, sleeve hem and bottom hem
Self fabric half moon at back neck



CREWNECK ETNA

CRU0012

| Unisex

| Oversized

| S - 2XL

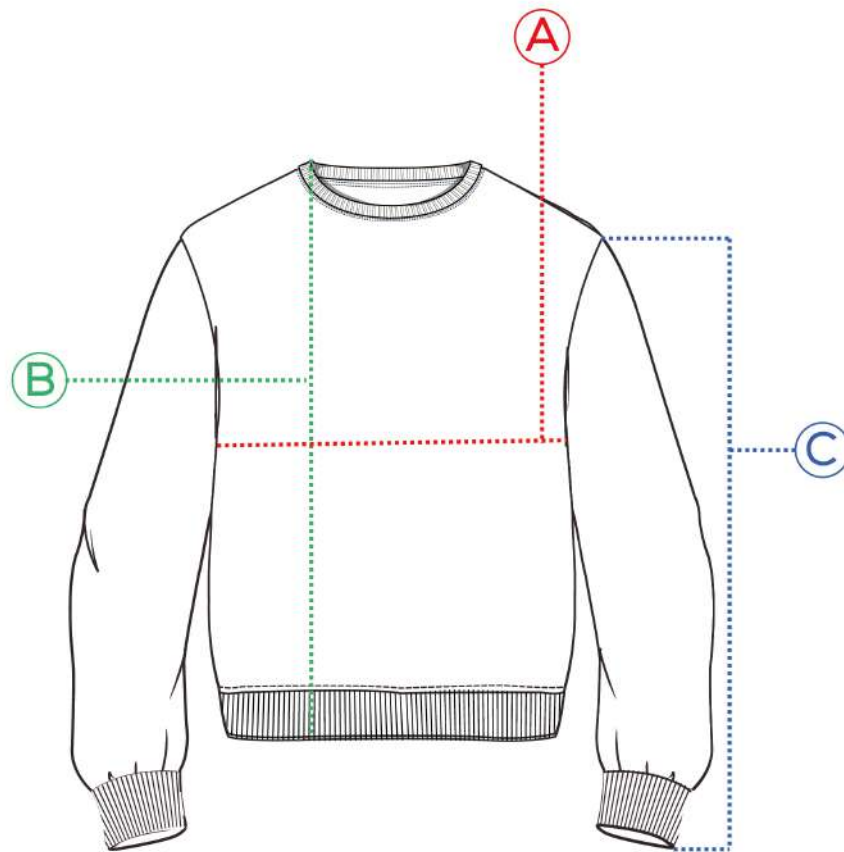

	S	M	L	XL	XXL
A	59	62	63	66	70
B	74	76	77	81	82
C	63	65	68	69	70

cm

CREWNECK HUDSON

CRU0013

Terry Sweatshirt
100% Organic Cotton
350 GSM
Vintage

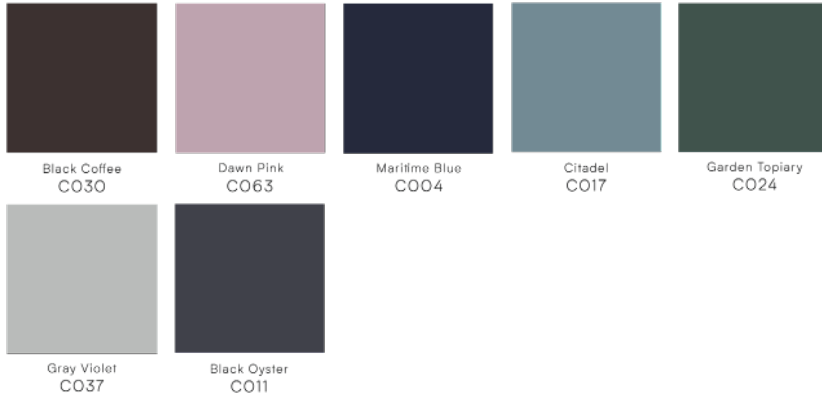

Specifications

1x1 rib at neck collar, sleeve hem and bottom hem
Self fabric half moon at back neck
Stone Wash



CREWNECK HUDSON

CRU0013

| Unisex

| Oversized

| S - 2XL

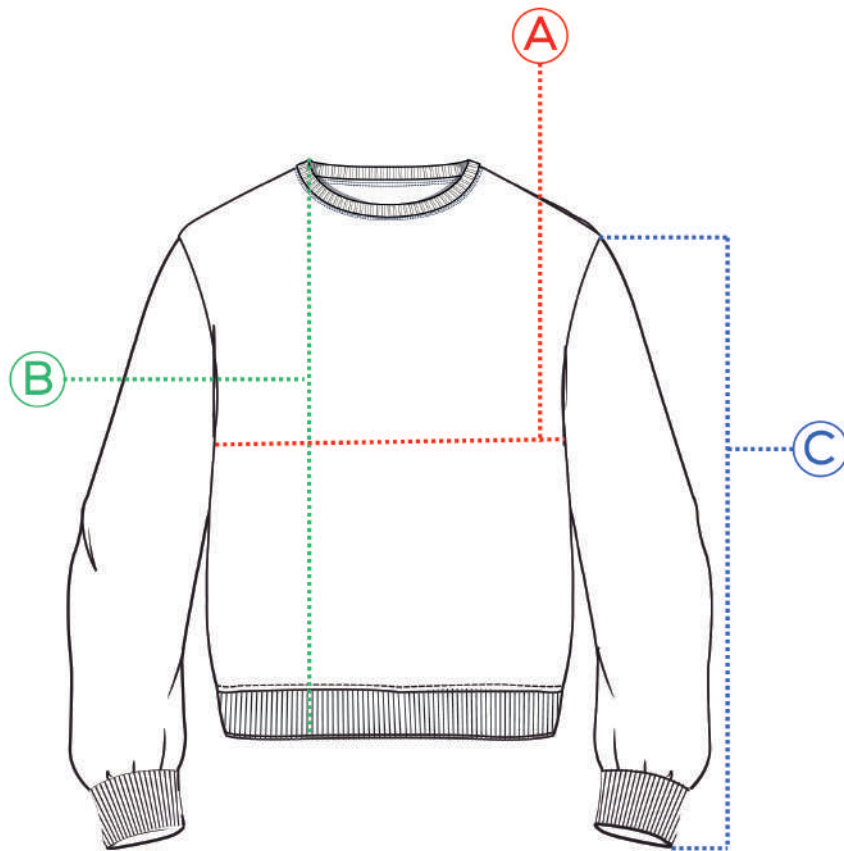

	S	M	L	XL	XXL
A	59	62	63	65	69
B	72	74	75	77	80
C	63	65	68	69	72

cm

CREWNECK PORTO

CRU033

Brushed sweatshirt
100% Cotton
420 GSM

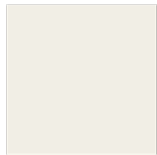

Coconut Milk
C003



Cocoa Brown
C1



Verde Botella
C022

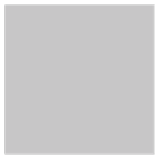

Glacier Gray
C052



Ebony
C029



Black
C002



Specifications

1x1 rib at neck collar, sleeve hem and bottom hem
Self fabric half moon at back neck

CREWNECK PORTO

CRU033

| Unisex

| Oversized

| S - 2XL

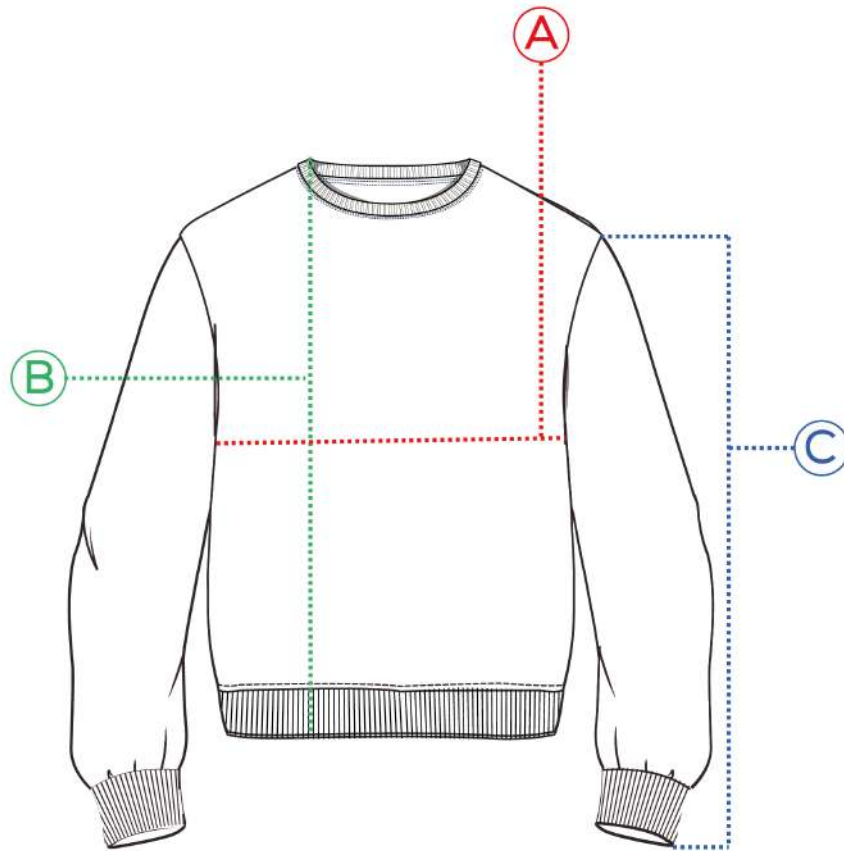

	S	M	L	XL	XXL
A	64	67	70	73	76
B	64	67	70	73	76
C	48	50	52	54	56

cm

OLUNKA

CRU0007

Terry sweatshirt
100% Organic Cotton
320 GSM



Specifications

1x1 rib at neck collar, sleeve hem and bottom hem
Self fabric half moon at back neck



OLUNKA

CRU0007

| Unisex

| Fitted

| S - 2XL

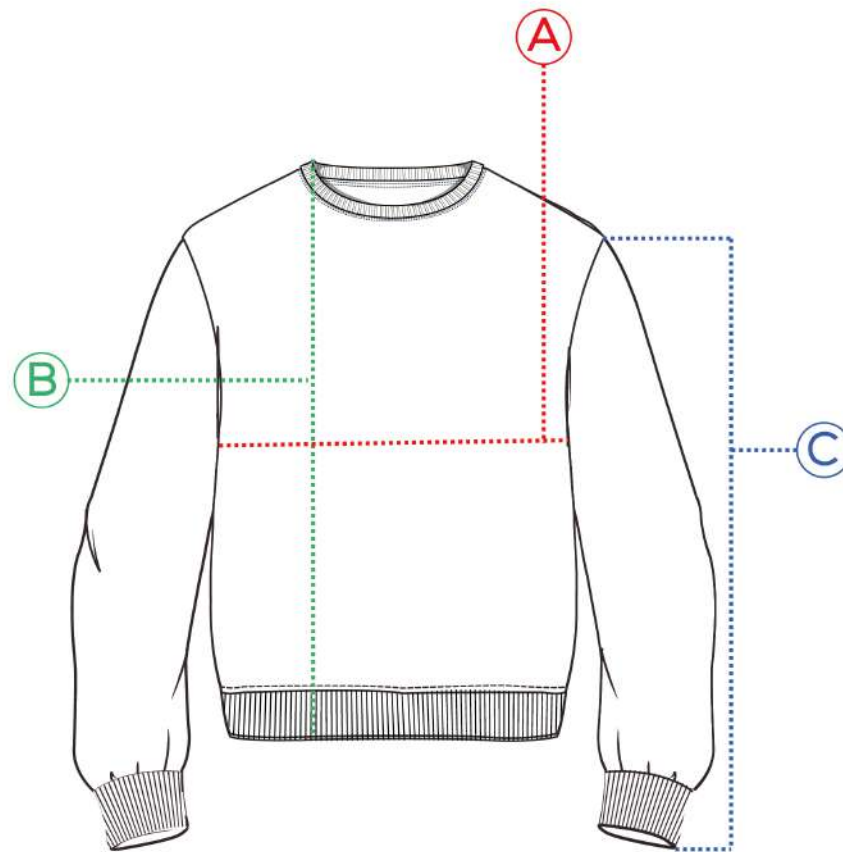

	S	M	L	XL	XXL
A	50	52	54	56	58
B	63	65	67	69	71
C	59	60	61	62	63

cm

OLUNKA MEDIUM

CRU022

Terry sweatshirt
100% Organic Cotton
320 GSM

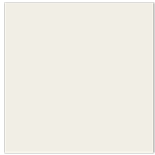

Coconut Milk
CO03



Black
CO02



Specifications

1x1 rib at neck collar, sleeve hem and bottom hem
Self fabric half moon at back neck



OLUNKA MEDIUM

CRU022

| Unisex

| Medium fit

| S - 2XL

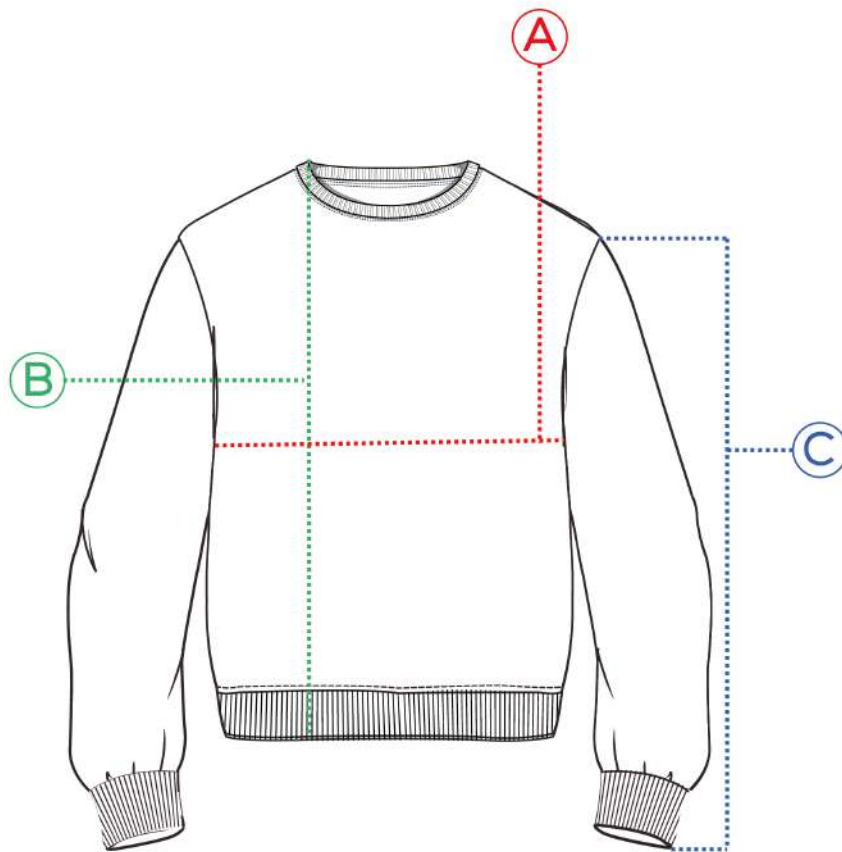

	S	M	L	XL	XXL
A	52	54	56	58	60
B	67,5	69,5	71,5	73,5	75,6
C	61	62	63	64	65

cm

TIMANFAYA

CRU0008

Terry sweatshirt
100% Cotton
320 GSM
Carbon effect

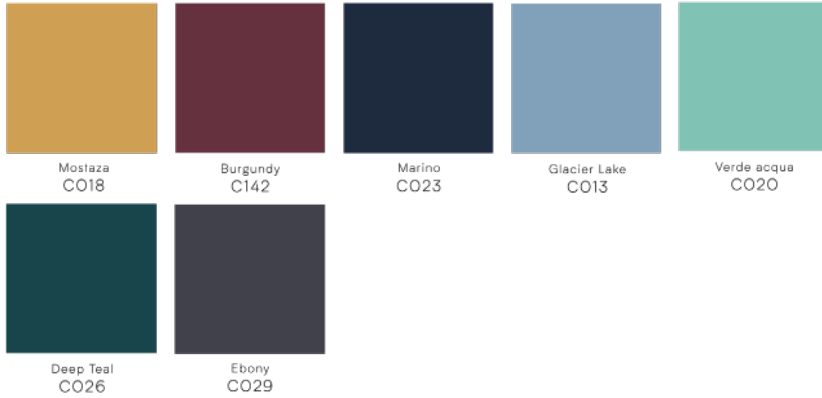

Specifications

2X2 rib at neck collar, sleeve hem and bottom hem
Self fabric half moon at back neck
Carbon effect
Peach touch

TIMANFAYA

CRU0008

| Unisex

| Medium fit

| S - 3XL

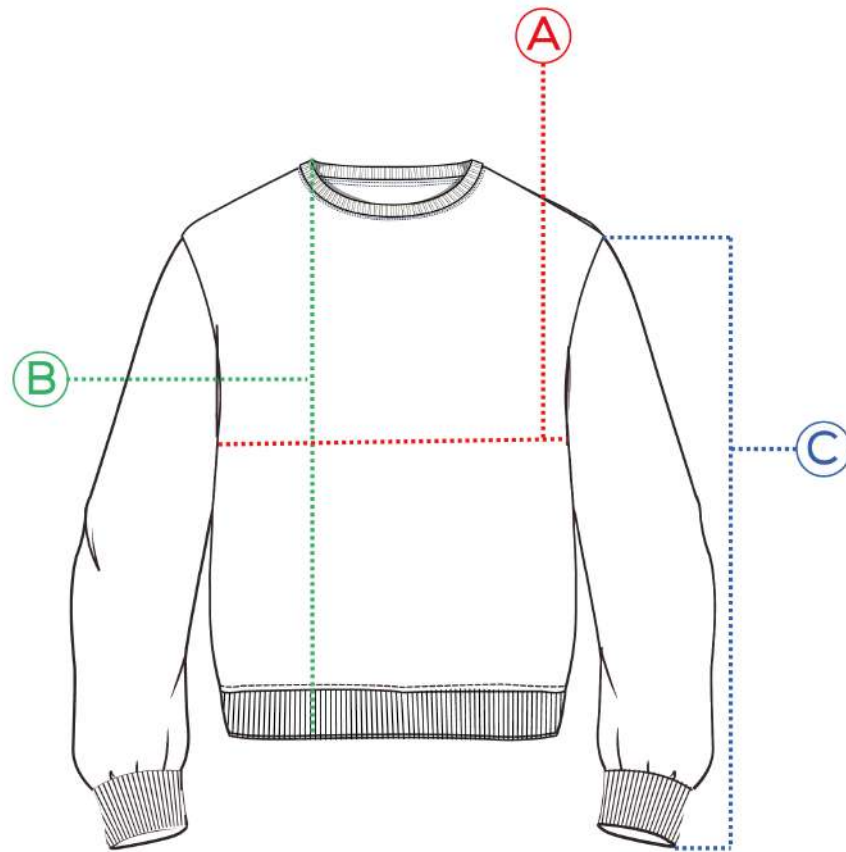

	S	M	L	XL	XXL
A	51,5	53,5	55,5	57,5	59,5
B	65	67	69	71	73
C	61	62	63	64	65

cm



HOODIES - ZIPPERS

DOLOMITAS
HOU0004

- 80% Cotton 20% Polyester ■
- 320 GSM ■
- Medium fit ■
- S - 2XL ■



ETNA SUPREME
HOU026

- 100% Cotton ■
- 500 GSM ■
- Oversized ■
- S - 2XL ■



HOODIE PENICHE
HOU021

- 80% Cotton 20% Polyester ■
- 320 GSM ■
- Oversized ■
- S - 2XL ■



HOODIE ETNA
HOU017

- 100% Organic Cotton ■
- 380 GSM ■
- Oversized ■
- S - 2XL ■



HOODIE PORTO
HOU039

- 100% Cotton ■
- 420 GSM ■
- Oversized ■
- S - 2XL ■



TEIDE
HOU0005

- 100% Organic Cotton ■
- 320 GSM ■
- Oversized ■
- S - 2XL ■



HOODIE HUDSON
HOU016

- 100% Organic Cotton ■
- 350 GSM ■
- Oversized ■
- S - 2XL ■
- Vintage ■



YELLOWSTONE
HOU0006

- 100% Organic Cotton ■
- 320 GSM ■
- Oversized ■
- S - 2XL ■
- Vintage ■



LAGOS
HOU020

- 80% Cotton 20% Polyester ■
- 320 GSM ■
- Oversized ■
- S - 2XL ■



ZIPPER PORTO
ZIPU036

- 100% Cotton ■
- 420 GSM ■
- Oversized ■
- S - 2XL ■



DOLOMITAS

HOU0004

Brushed sweatshirt
80% Cotton 20% Polyester
320 GSM



Specifications

- 1x1 rib at bottom hem and sleeve hem
- Self fabric half moon at back neck
- Lined hood
- Metal eyelets
- Round drawcords in matching body colour
- Set-in sleeve
- Kangaroo pocket at front

DOLOMITAS

HOU0004

| Unisex

| Medium fit

| S - 2XL

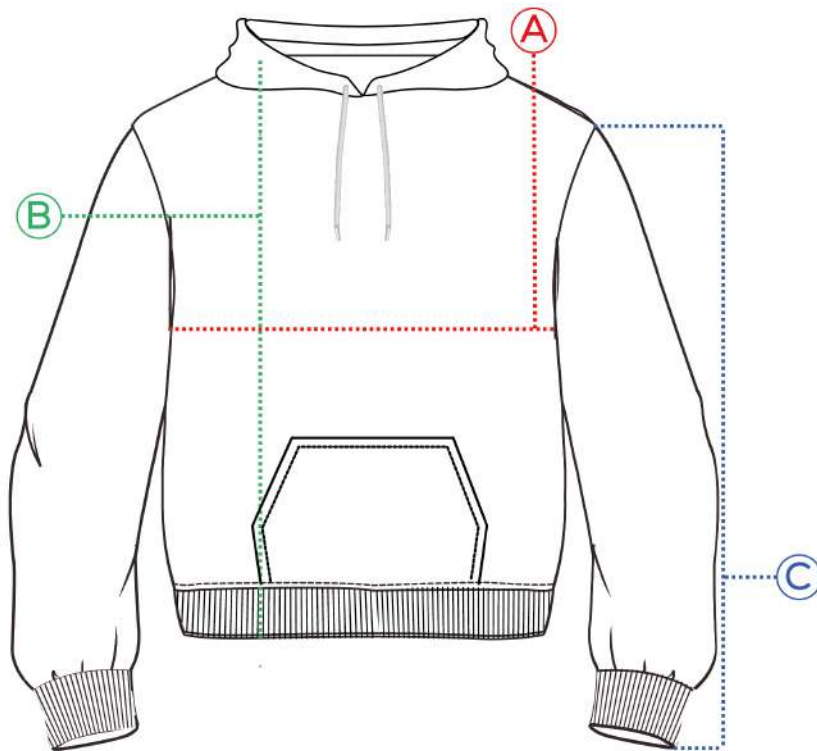

	S	M	L	XL	XXL
A	52	57	58	63	65
B	70	74	75,5	76,5	78,5
C	64	66	68	70	70

cm

HOODIE ETNA

HOU017

Terry sweatshirt
100% Organic Cotton
380 GSM

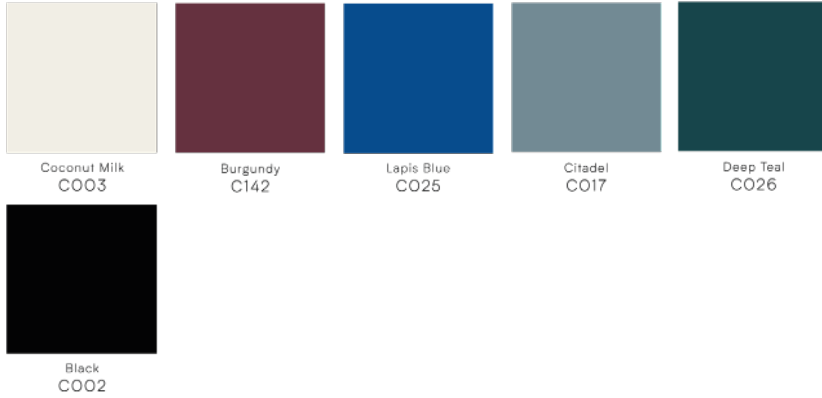

Specifications

- 1x1 rib at bottom hem and sleeve hem
- Self fabric half moon at back neck
- Lined hood
- Kangaroo pocket at front



HOODIE ETNA

HOU017

| Unisex

| Oversized

| S - 2XL

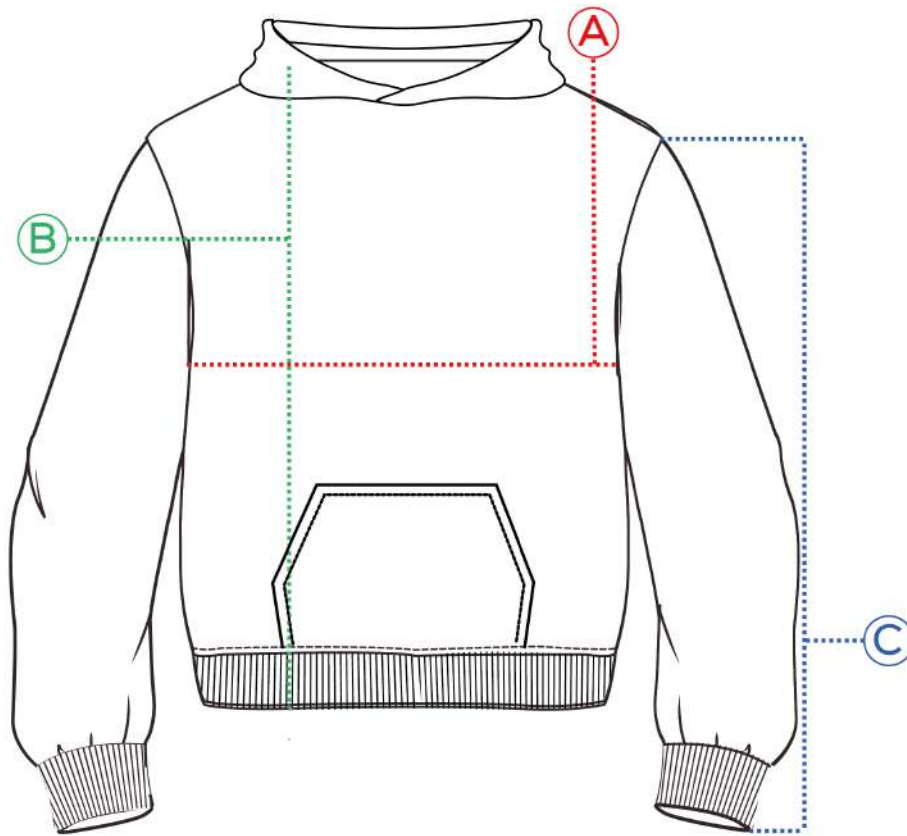

	S	M	L	XL	XXL
A	59	61	63	65	67
B	72	74	76	78	80
C	61	63	65	67	69

cm

ETNA SUPREME

HOU026

Terry sweatshirt
100% Cotton
500 GSM

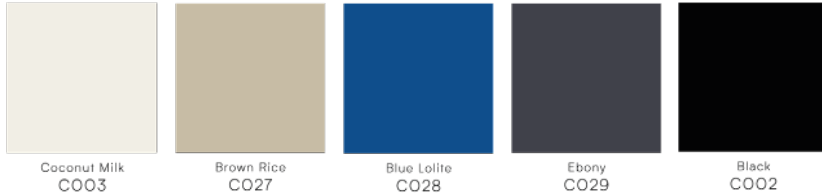

Specifications

1x1 rib at bottom hem and sleeve hem
Self fabric half moon at back neck
Lined hood
Kangaroo pocket at front

ETNA SUPREME

HOU026

| Unisex

| Oversized

| S - 2XL

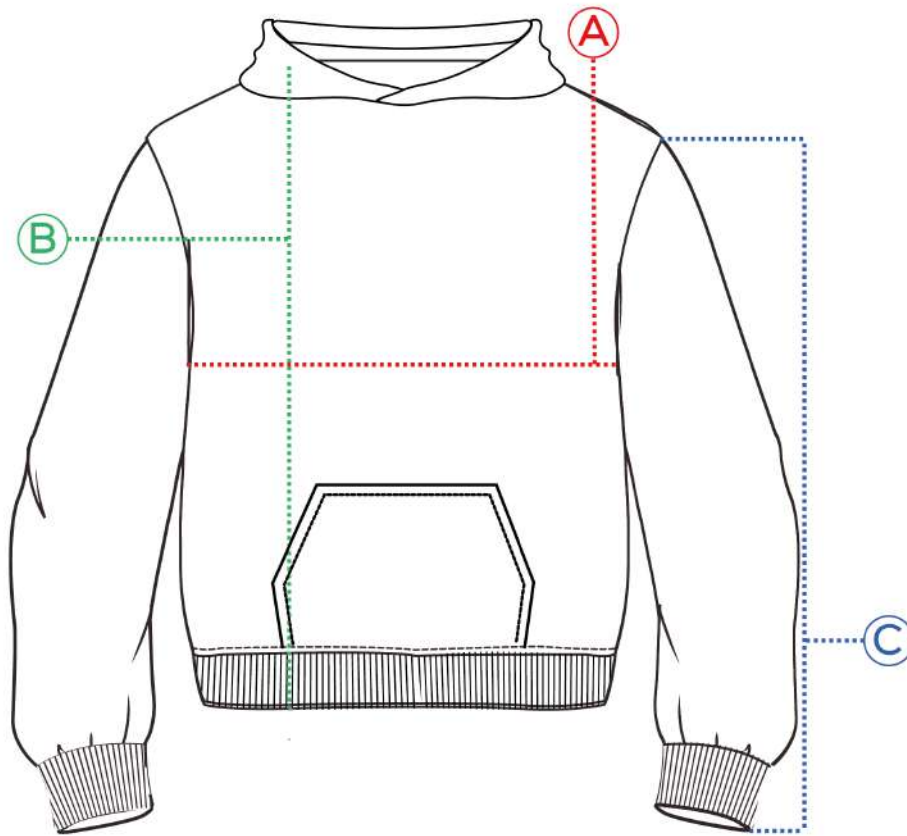

	S	M	L	XL	XXL
A	64	67	70	73	76
B	64	67	70	73	76
C	48	50	52	54	56

cm

HOODIE PORTO

HOU039

Brushed sweatshirt
100% Cotton
420 GSM

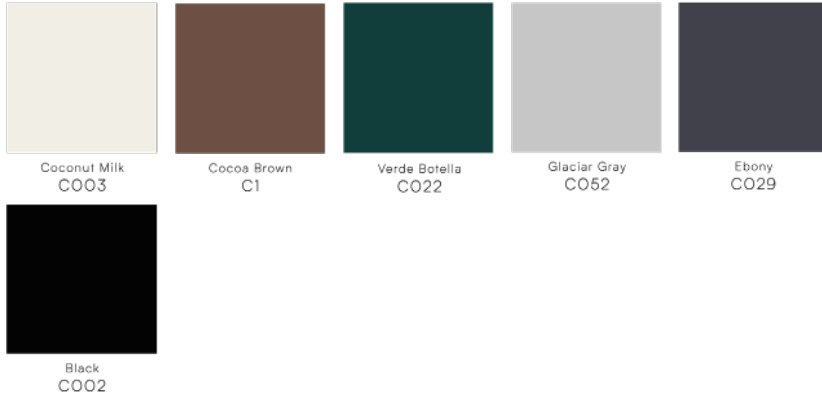

Specifications

1x1 rib at bottom hem and sleeve hem
Self fabric half moon at back neck
Lined hood
Kangaroo pocket at front

HOODIE PORTO

HOU039

| Unisex

| Oversized

| S - 2XL

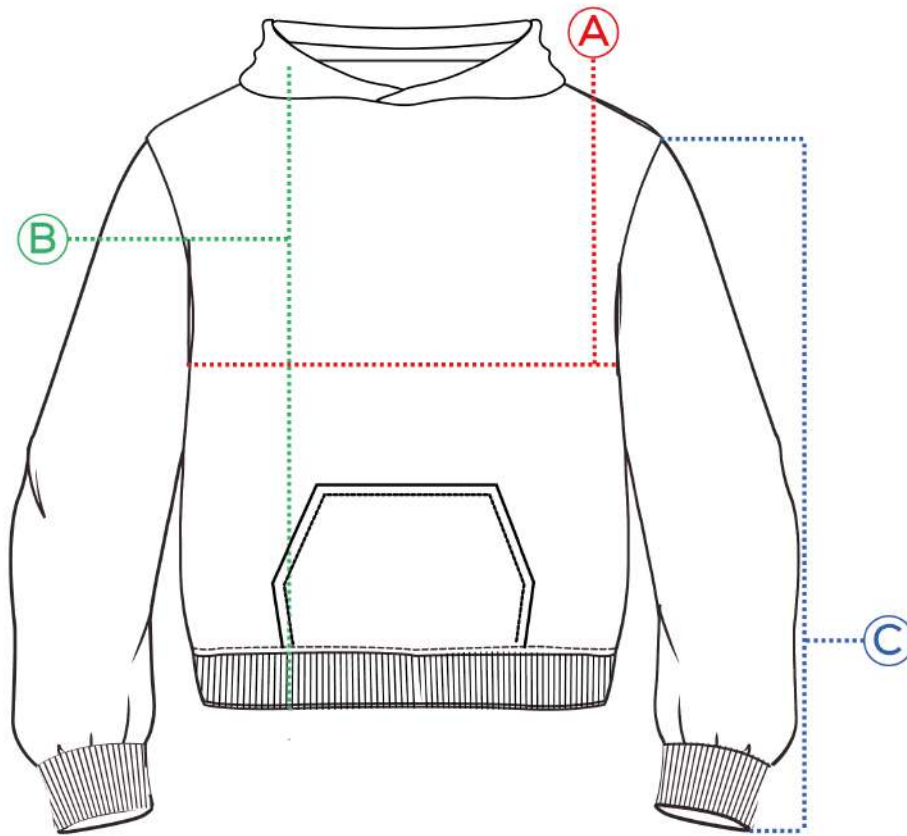

	S	M	L	XL	XXL
A	59	61	63	65	67
B	72	74	76	78	80
C	61	63	65	67	69

cm

HOODIE HUDSON

HOU016

Terry sweatshirt
100% Organic Cotton
350 GSM
Vintage



Specifications

1x1 rib at bottom hem and sleeve hem
Self fabric half moon at back neck
Lined hood
Kangaroo pocket at front
Stone Wash



HOODIE HUDSON

HOU016

| Unisex

| Oversized

| S - 2XL

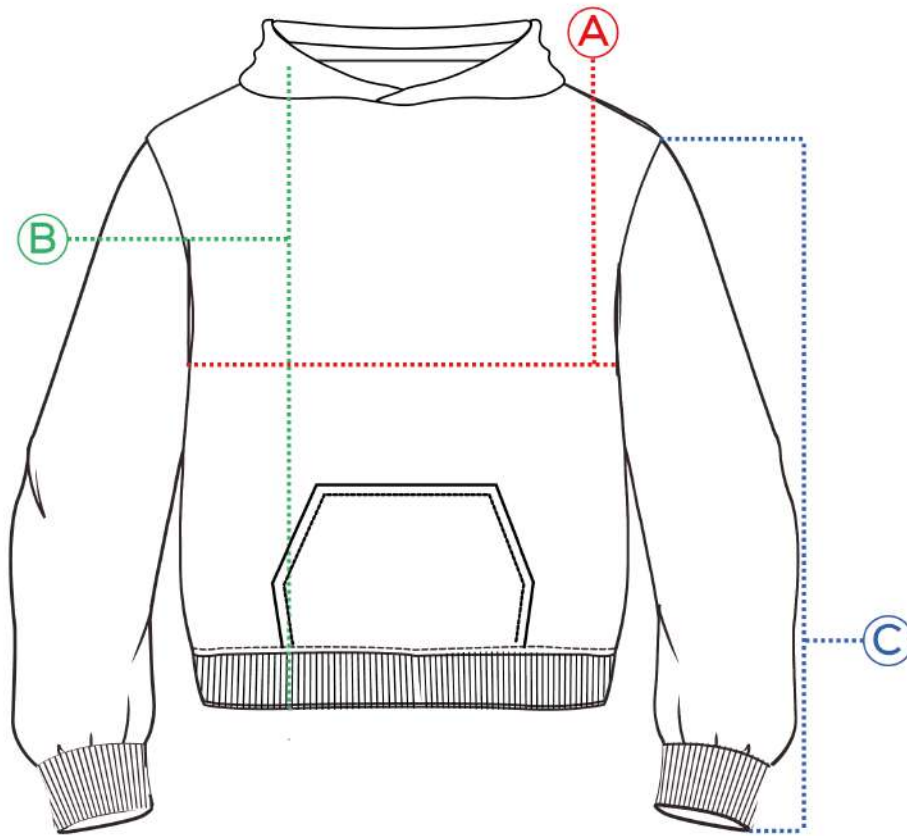

	S	M	L	XL	XXL
A	64	66	68	70	72
B	67	69	72	73	75
C	63,5	64,5	65,5	66,5	67,5

cm

LAGOS

HOU020

Terry sweatshirt
80% Cotton 20% Polyester
320 GSM

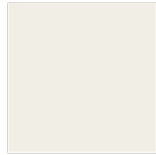

Coconut Milk
CO03



Black Coffee
CO30



Black
CO02



Specifications

- 1x1 rib at bottom hem and sleeve hem
- Self fabric half moon at back neck
- Lined hood
- Kangaroo pocket at front

LAGOS

HOU020

| Unisex

| Oversized

| S - 2XL

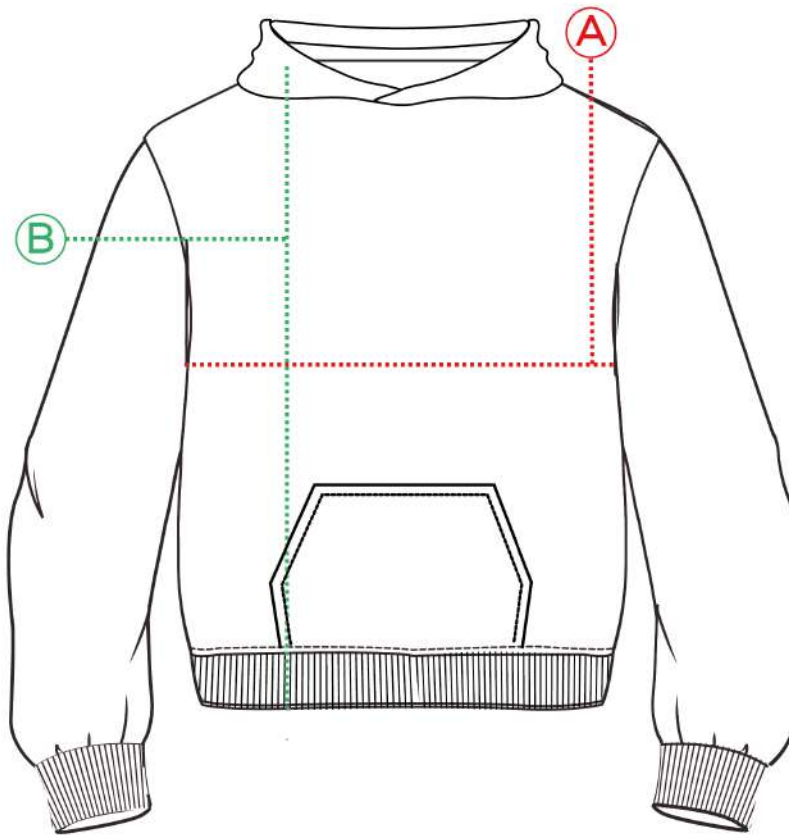

	S	M	L	XL	XXL
A	64	66	68	70	72
B	67	69	71	73	75

cm

HOODIE PENICHE

HOU021

Brushed sweatshirt
80% Cotton 20% Polyester
320 GSM



Specifications

1x1 rib at bottom hem and sleeve hem

Self fabric half moon at back neck

Lined hood

Kangaroo pocket at front

HOODIE PENICHE

HOU021

| Unisex

| Oversized

| S - 2XL

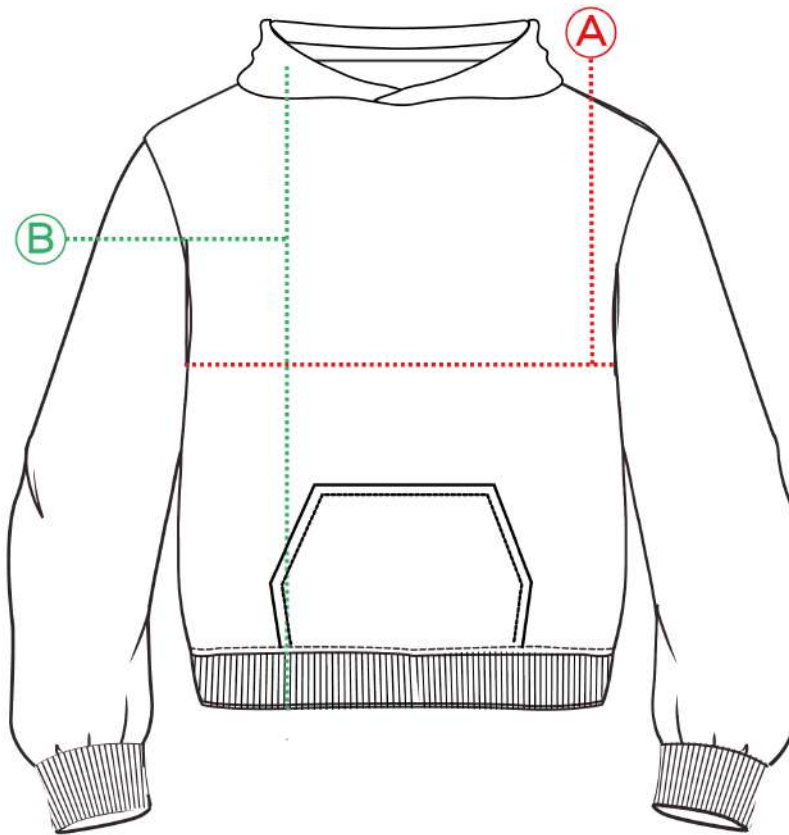

	S	M	L	XL	XXL
A	64	66	68	70	72
B	67	69	71	73	75

cm

TEIDE

HOU0005

Terry sweatshirt
100% Organic Cotton
320 GSM

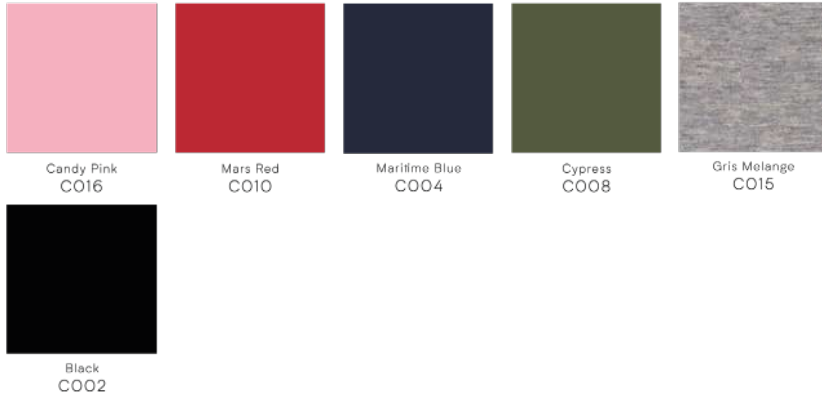

Specifications

- 1x1 rib at bottom hem and sleeve hem
- Self fabric half moon at back neck
- Lined hood
- Metal eyelets
- Round drawcords in matching body colour
- Kangaroo pocket at front



TEIDE

HOU0005

| Unisex

| Oversized

| S - 2XL

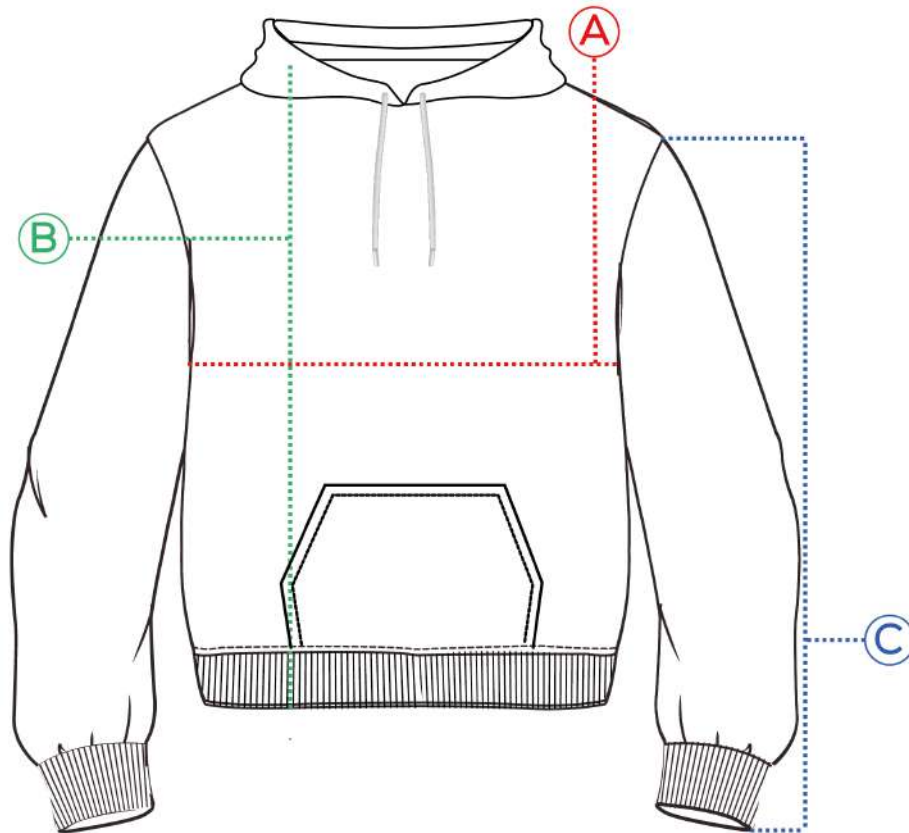

	S	M	L	XL	XXL
A	59	61	63	65	67
B	72	74	76	78	80
C	61	63	65	67	69

cm

YELLOWSTONE

HOU0006

Terry sweatshirt
100% Organic Cotton
320 GSM
Vintage

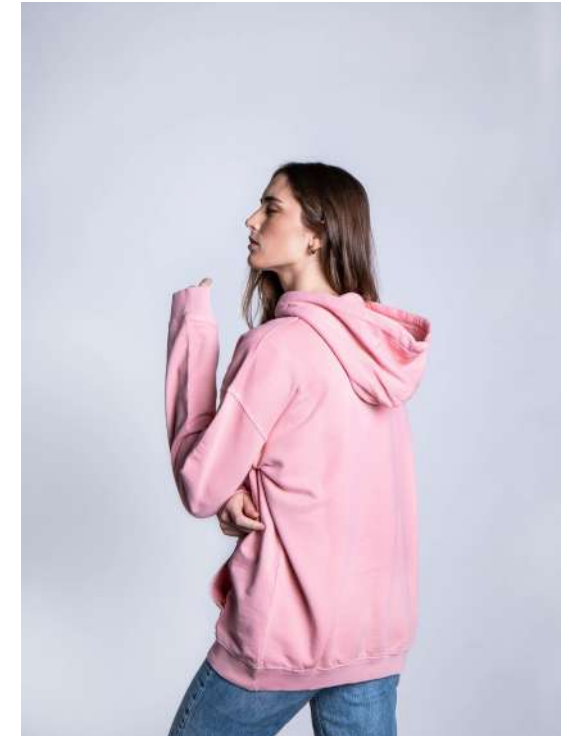
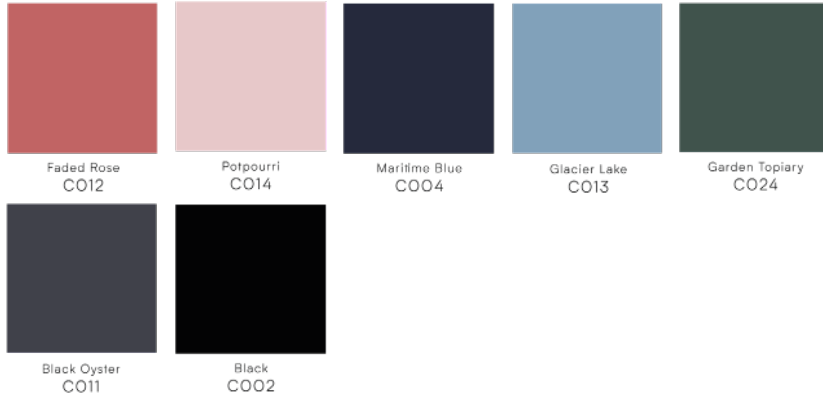

Specifications

- 1x1 rib at bottom hem and sleeve hem
- Self fabric half moon at back neck
- Lined hood
- Metal eyelets
- Round drawcords in matching body colour with metal tipping
- Kangaroo pocket at front
- Stone Wash



YELLOWSTONE

HOU0006

| Unisex

| Oversized

| S - 2XL

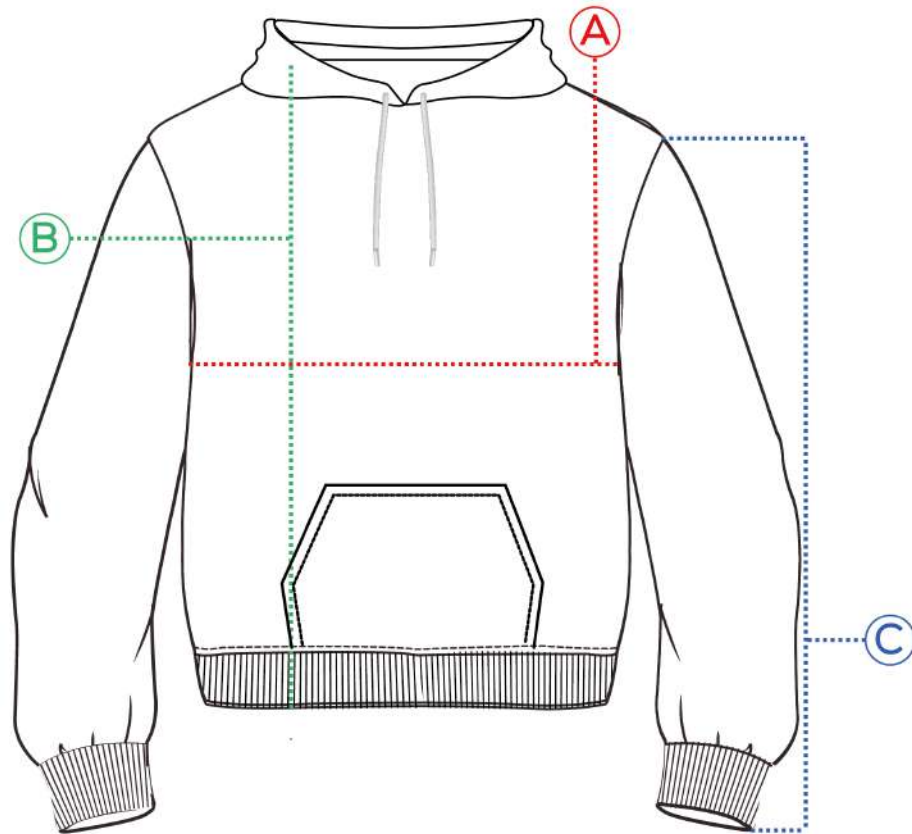

	S	M	L	XL	XXL
A	59	61	63	65	67
B	72	74	76	78	80
C	61	63	65	67	69

cm

ZIPPER PORTO

ZIPU036

Brushed sweatshirt
100% Cotton
420 GSM

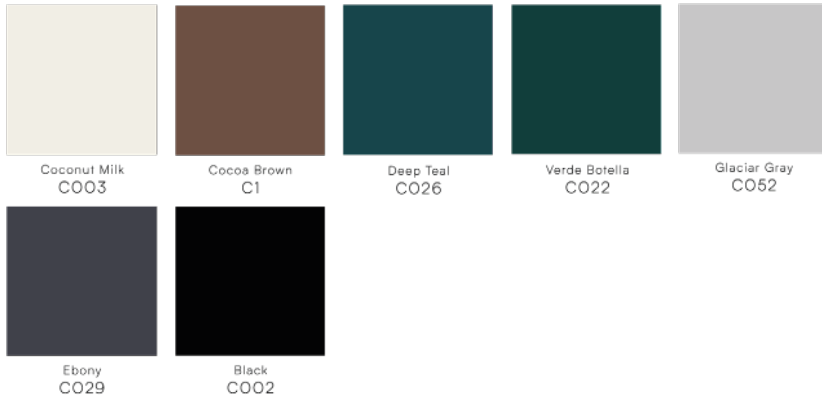

Specifications

1x1 rib at bottom hem and sleeve hem
Self fabric half moon at back neck
Lined hood
Metal zip
Kangaroo pocket at front

ZIPPER PORTO

ZIPU036

| Unisex

| Oversized

| S - 2XL

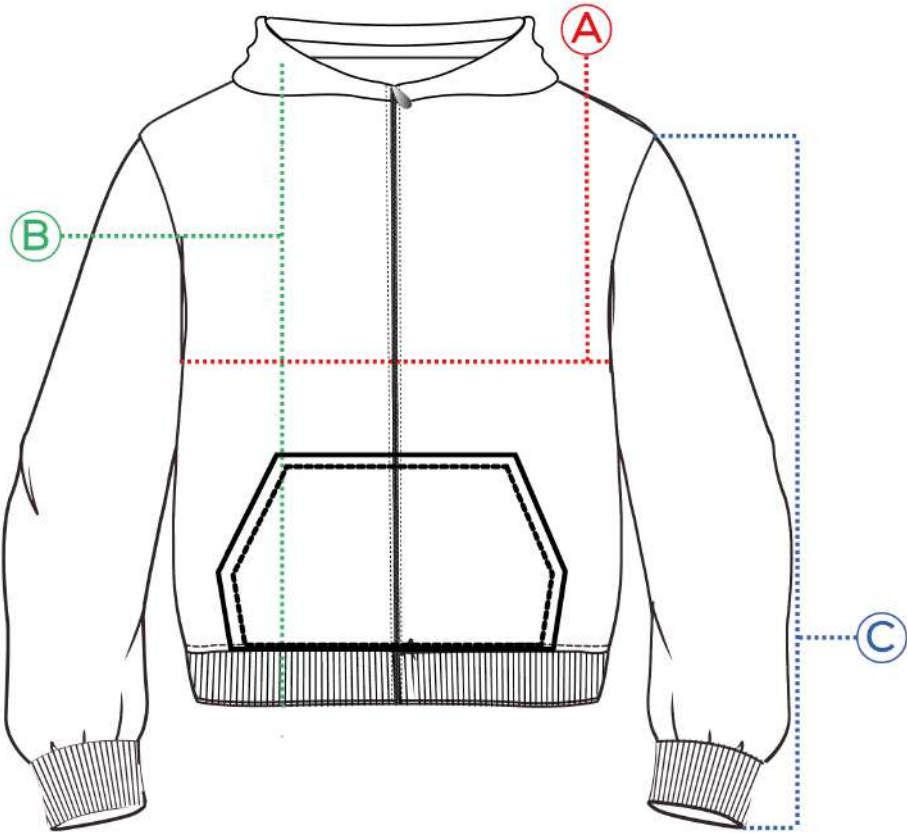

	S	M	L	XL	XXL
A	64	67	70	73	76
B	64	67	70	73	76
C	48	50	52	54	56

cm

Unisex

HALF ZIPS



ALASKA
HALU014

- 100% Recycled Polyester
- 280 GSM
- Relaxed fit
- S - 2XL



ZION
HALU0011

- 100% Organic Cotton
- 350 GSM
- Medium fit
- S - 2XL
- Vintage



DURMITOR
HALU0010

- 80% Cotton 20% Polyester
- 350 GSM
- Medium fit
- S - 2XL



HALF ZIP PENICHE
HALU042

- 80% Cotton 20% Polyester
- 185 GSM
- Medium fit
- S - 2XL



MALIBU
HALU035

- 100% Organic Cotton
- 350 GSM
- Oversized
- S - 2XL
- Vintage



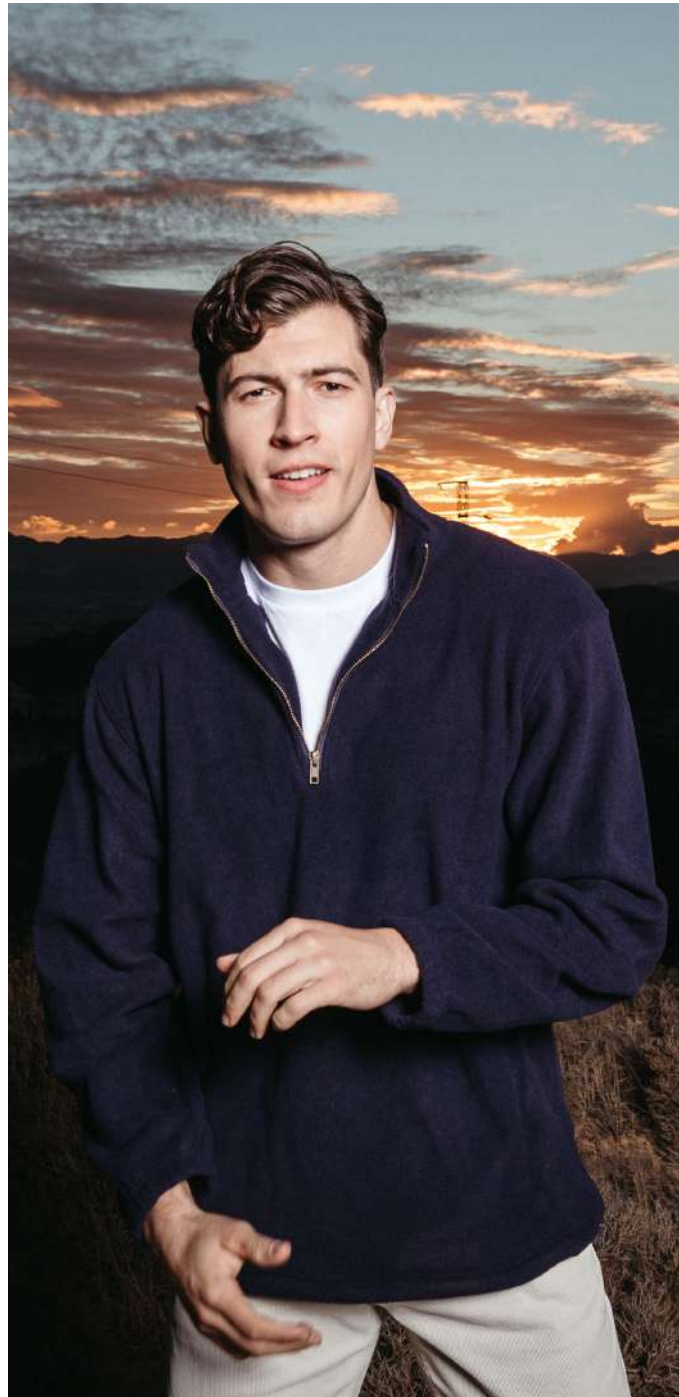

ALASKA

HALU014

Micro Fleece
100% Recycled Polyester
280 GSM

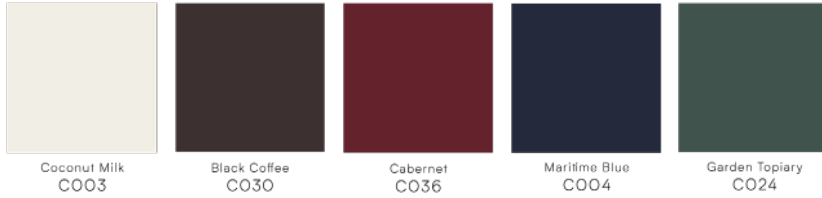

Specifications

- Neck collar in self fabric
- Self fabric half moon at back neck
- Quarter zip at centre front with inside facing
- Zippered welt pockets
- Bottom hem with adjustable plastic stopper and elastic cord

ALASKA

HALU014

| Unisex

| Relaxed fit

| S - 2XL

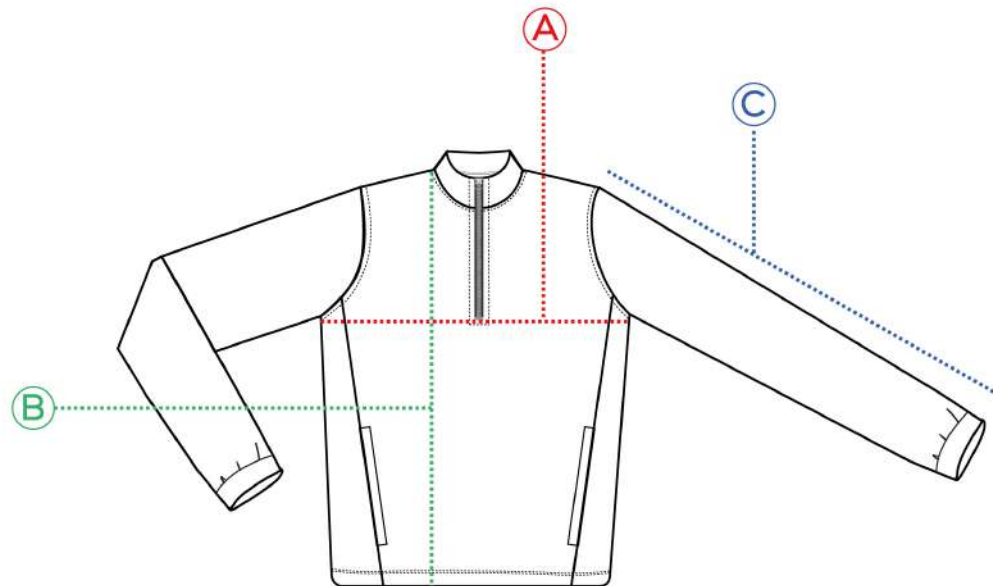

	S	M	L	XL	XXL
A	56	58	60	62	64
B	71	73	75	77	79
C	63	64	65	66	67

cm

DURMITOR

HALU0010

Terry sweatshirt
80% Cotton 20% Polyester
320 GSM

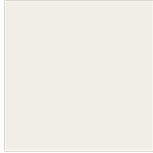

Coconut Milk
C003



Maritime Blue
C004



Gris Melange
C015



Specifications

Neck collar in self fabric
Self fabric half moon at back neck
Quarter zip at centre front with inside facing
Raglan sleeve
1X1 rib at sleeve hem and bottom hem

DURMITOR

HALU0010

| Unisex

| Medium fit

| S - 2XL

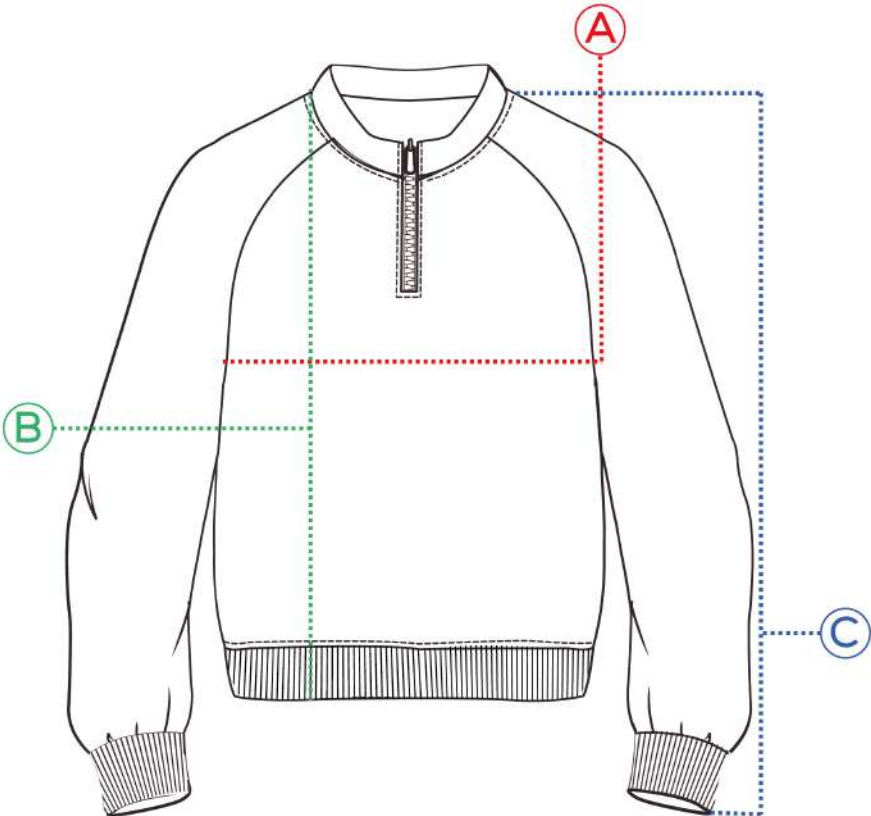

	S	M	L	XL	XXL
A	57	59	61	63	65
B	68	70	72	74	76
C	81	82	83	84	85

cm

HALF ZIP PENICHE

HALU042

Brushed sweatshirt
80% Cotton 20% Polyester
320 GSM

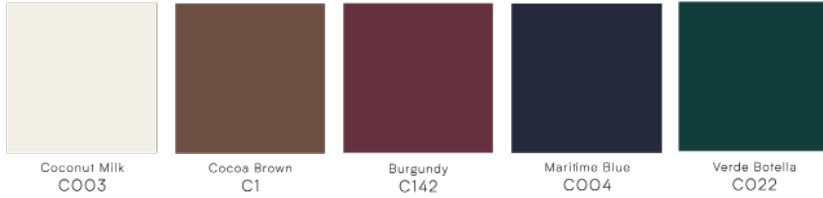

Specifications

Neck collar in self fabric
Self fabric half moon at back neck
Quarter zip at centre front with inside facing
1X1 rib at sleeve hem and bottom hem

HALF ZIP PENICHE

HALU042

| Unisex

| Medium fit

| S - 2XL

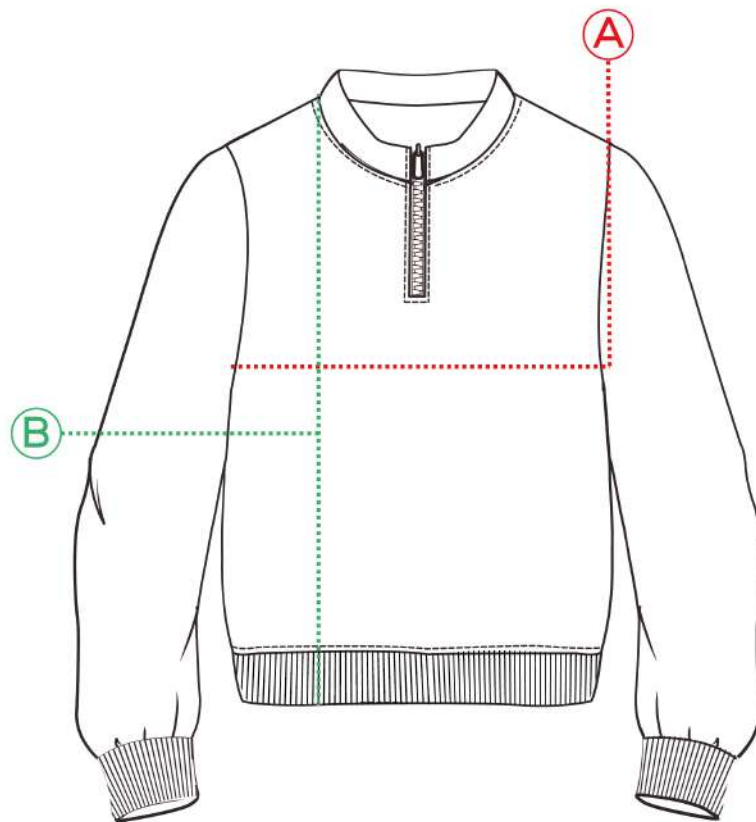

	S	M	L	XL	XXL
A	57	59	61	63	65
B	68	70	72	74	76

cm

MALIBU

HALU035

Terry sweatshirt
100% Organic Cotton
350 GSM
Vintage



Cannoli Cream
C042



Dark Denim
C045



Black Oyster
C011



Specifications

Neck collar in self fabric
Self fabric half moon at back neck
Quarter zip at centre front with inside facing
1X1 rib at sleeve hem and bottom hem
Stone Wash



MALIBU

HALU035

| Unisex

| Oversized

| S - 2XL

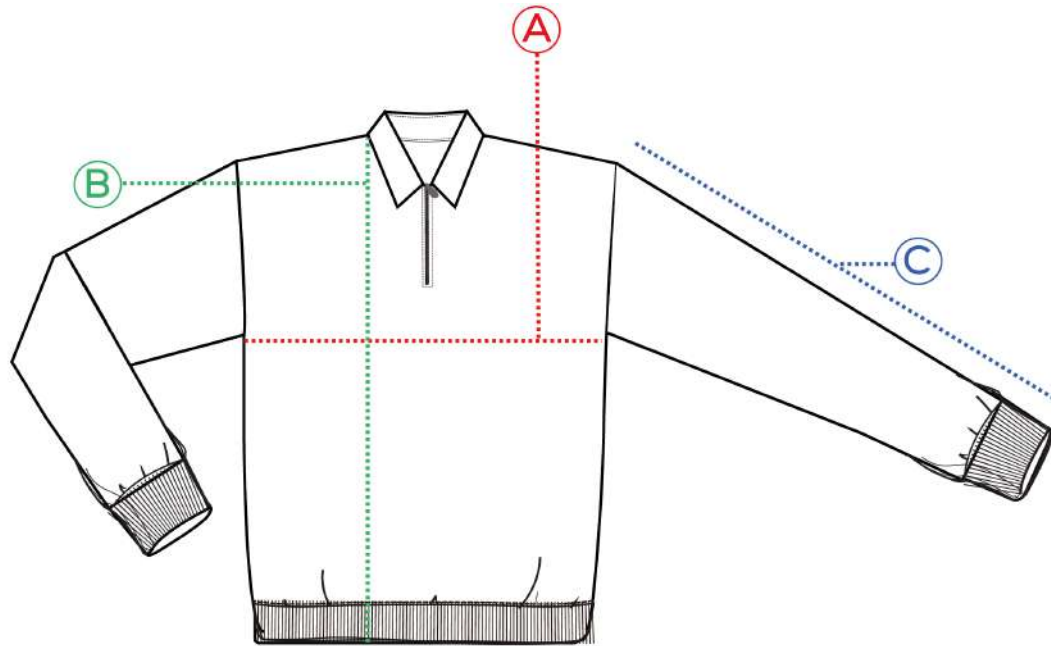

	S	M	L	XL	XXL
A	59	61	63	65	67
B	66	68,6	71,1	73,7	76,2
C	59	61	63	65	67

cm

ZION

HALU0011

Terry sweatshirt
100% Organic Cotton
350 GSM
Vintage



Maritime Blue
C004



Glacier Lake
C013

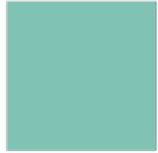

Verde acqua
C020



Gray Violet
C037



Specifications

Neck collar in self fabric
Self fabric half moon at back neck
Quarter zip at centre front with inside facing
Raglan sleeve
1X1 rib at sleeve hem and bottom hem
Stone Wash



ZION

HALU0011

| Unisex

| Medium fit

| S - 2XL

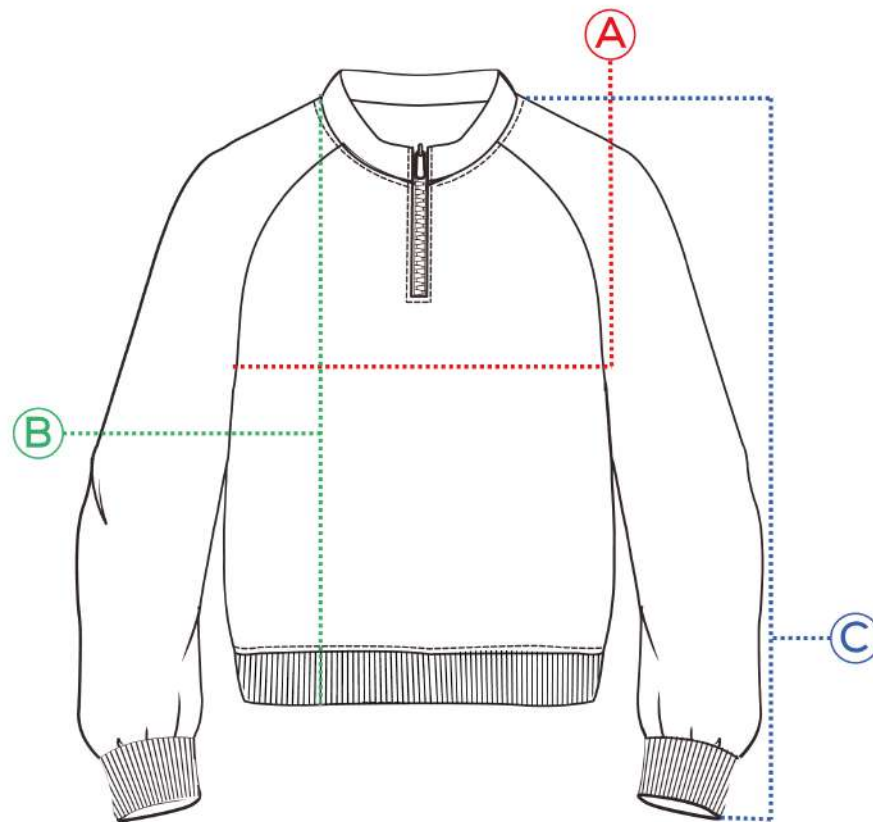

	S	M	L	XL	XXL
A	57	59	61	63	65
B	68	70	72	74	76
C	81	82	83	84	85

cm





Unisex

Bottoms

ERICEIRA SHOU037

- 80% Cotton 20% Polyester ■
- 320 GSM ■
- Relaxed fit ■
- S - 2XL ■



JOGGER PENICHE JOGU025

- 80% Cotton 20% Polyester ■
- 320 GSM ■
- Relaxed fit ■
- S - 2XL ■



JOGGER PORTO JOGU040

- 100% Cotton ■
- 420 GSM ■
- Relaxed fit ■
- S - 2XL ■



ERICEIRA

SHOU037

French terry
80% Cotton 20% Polyester
320 GSM

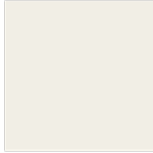

Coconut Milk
C003



Black
C002



Specifications

- Self fabric elasticated waistband
- Embroidered eyelets
- Flat drawcords in matching body colour
- Pocket lining in terry sweatshirt

ERICEIRA

SHOU037

| Unisex

| Relaxed fit

| S - 2XL

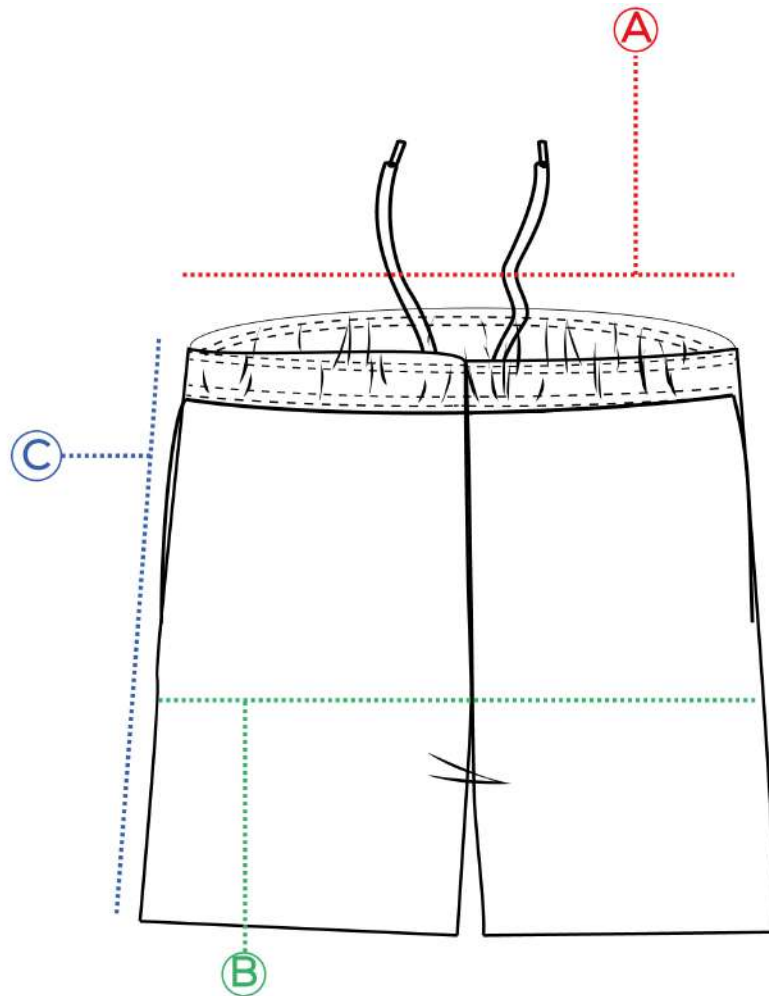

	S	M	L	XL	XXL
A	38	40	42	44	46
B	57	59	61	63	65
C	48	50	52	54	56

cm

JOGGER PENICHE

JOGU025

Brushed
80% Cotton 20% Polyester
320 GSM

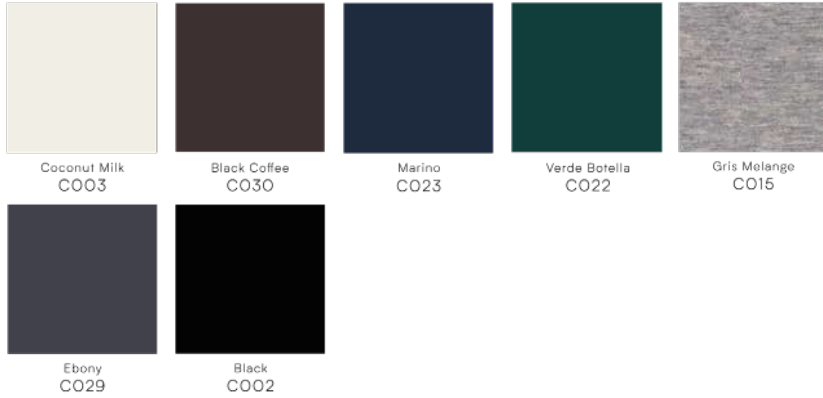

Specifications

- Elastic at waistband and bottom hem
- Metal eyelets
- Flat drawcords in matching body colour
- Pocket lining in brushed sweatshirt

JOOPER PENICHE

JOGU025

| Unisex

| Relaxed fit

| S - 2XL

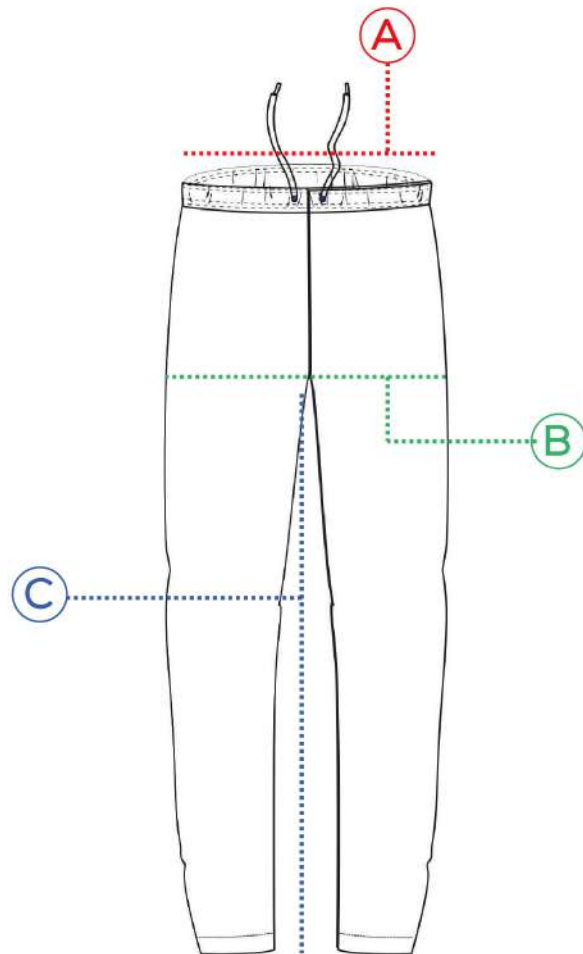

	S	M	L	XL	XXL
A	36,5	38,5	40,5	42,5	44,5
B	51	53	55	57	59
C	72	73	74	75	76

cm

JOGGER PORTO

JOGU040

Brushed
100% Cotton
420 GSM

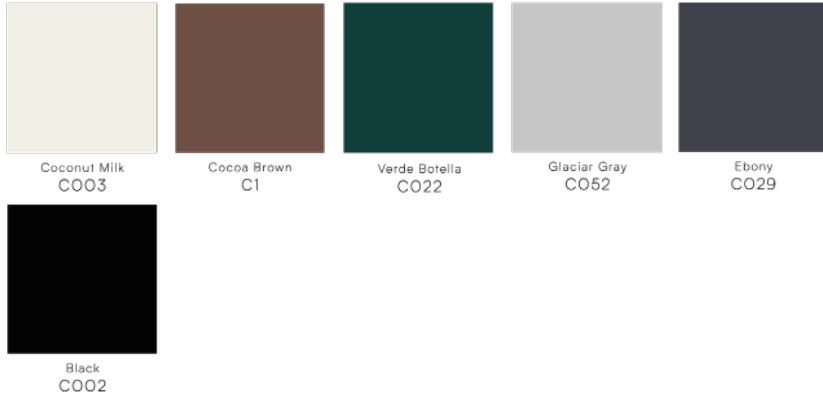

Specifications

- Elastic at waistband and bottom hem
- Metal eyelets
- Flat drawcords in matching body colour
- Pocket lining in brushed sweatshirt

JOGGER PORTO

JOGU040

| Unisex

| Relaxed fit

| S - 2XL

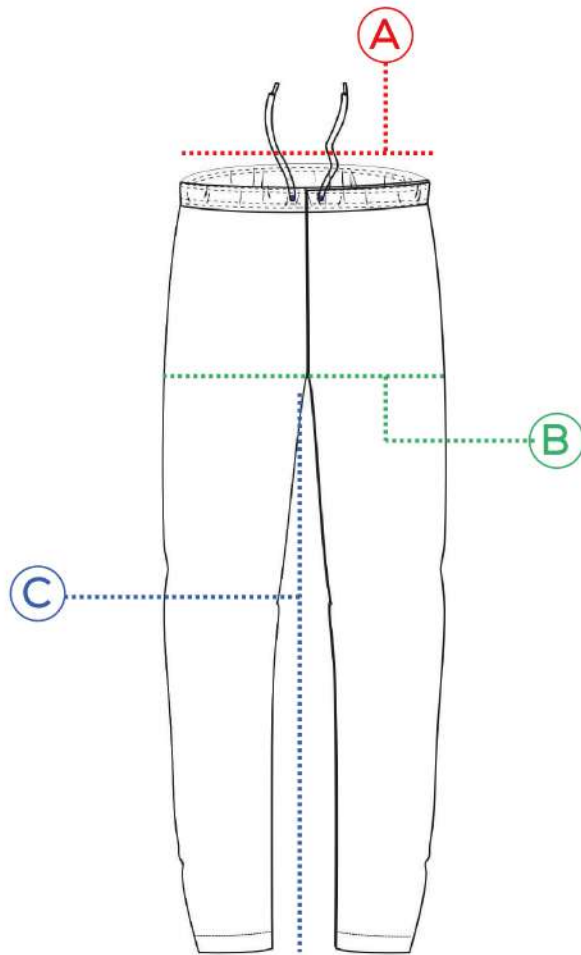

	S	M	L	XL	XXL
A	36,5	38,5	40,5	42,5	44,5
B	51	53	55	57	59
C	72	73	74	75	76

cm

Unisex

Shirts



FORMENTERA
CAMU028

- 100% Linen
- 125 GSM
- Medium fit
- S - 2XL
- Vintage



MENORCA
CSMU027

- 100% Linen
- 125 GSM
- Medium fit
- S - 2XL
- Vintage





FORMENTERA

CAMU028

Woven linen
100% Linen
125 GSM
Vintage

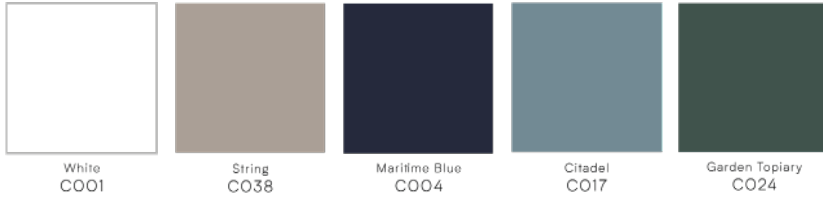

Specifications

Polo shirt
sleeve cuff with 2 button
sleeve placket with 1 small button
curved bottom hem
Spare buttons attached on composition label
Stone Wash

FORMENTERA

CAMU028

| Unisex

| Medium fit

| S - 2XL

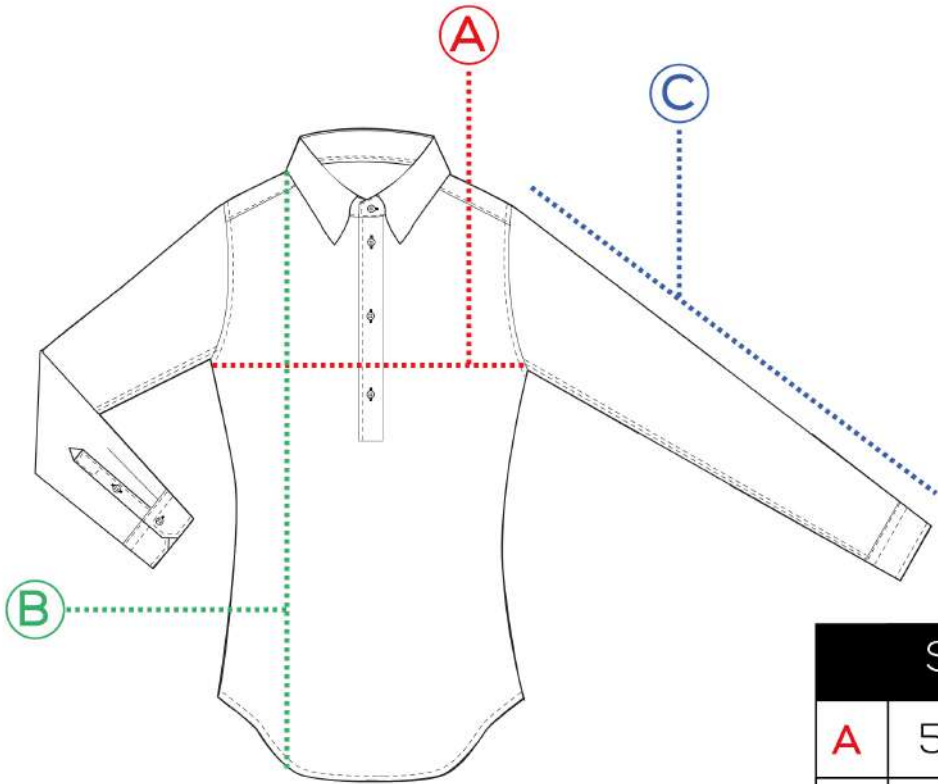

	S	M	L	XL	XXL
A	56	58	60	62	64
B	73	74	75	76	77
C	63	63,5	64	64,5	65

cm

MENORCA

CAMU027

Woven linen
100% Linen
125 GSM
Vintage

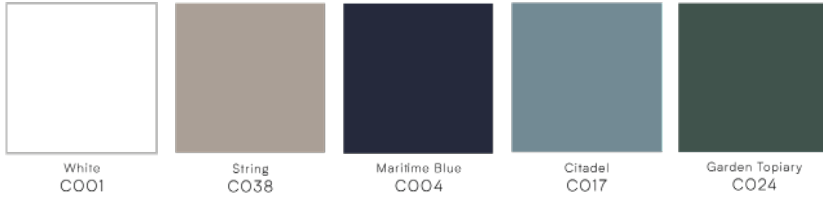

Specifications

sleeve cuff with 2 button
sleeve placket with 1 small button
curved bottom hem
Spare buttons attached on composition label
Stone Wash

MENORCA

CAMU027

| Unisex

| Medium fit

| S - 2XL

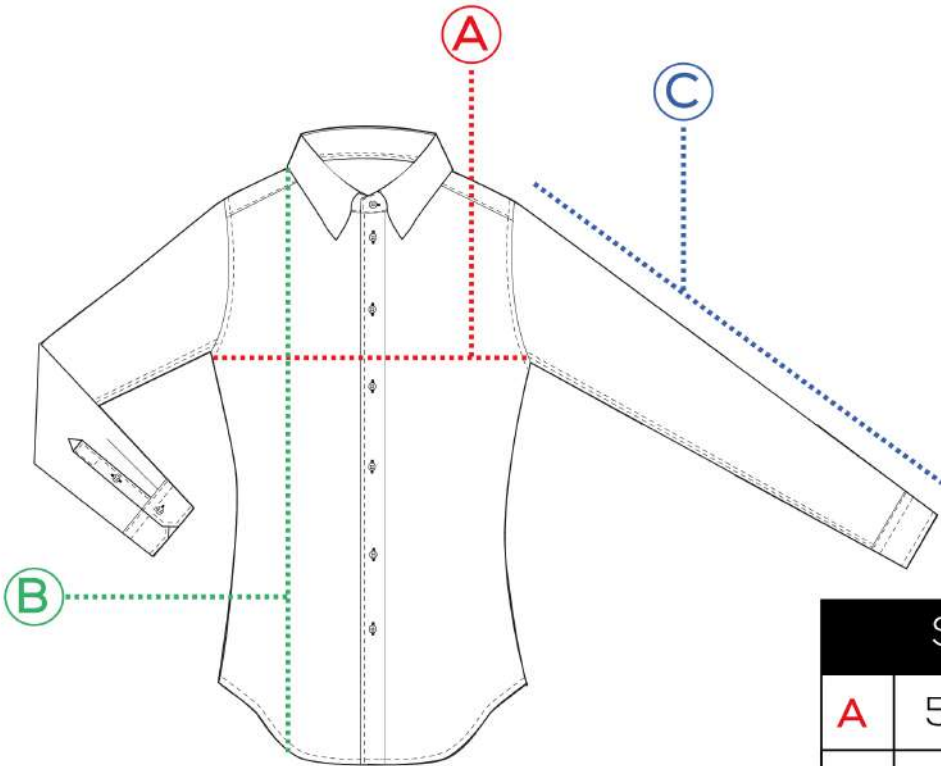

	S	M	L	XL	XXL
A	56	58	60	62	64
B	73	74	75	76	77
C	63	63,5	64	64,5	65

cm

Manufacturer of Clothes - Blan X +

← → C https://www.oltextrading.com

OLTEX trading

SHOP ABOUT US CONTACT | Q  

 CREWNECKS  HOODIES  T-SHIRTS  POLOS  HALF ZIPS  JOGGER  SHIRT

↙

**New colour palette
SS24**



Colour name
Code



White
CO01

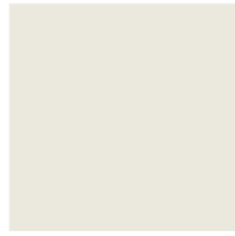

Coconut Milk
CO03



Summer Sand
CO41



Fog
CO43



Brown Rice
CO27



String
CO38



Double Cream
CO65



Cocoa Brown
C1



Black Coffee
CO30



Burgundy
C142



Cabernet
CO36



Cameo Brown
CO35



Dusty Rose
CO53



Shell Pink
CO69



Candy Pink
CO16



Fairy Tale
CO64



Mars Red
CO10



Fiery Red
CO40



Dawn Pink
CO63



Purple Rose
CO33



Royal Blue
C135



Lapis Blue
C025



Blue Lolite
C028



Maritime Blue
C004



Marino
C023



Pageant Blue
C044



Dark Denim
C045



Citadel
C017



Chambray Blue
C066



Soothing Sea
C070



Iceberg Green
C051



Reflecting pond
C046



Deep Teal
C026



Eden
C039



Verde Botella
C022



Botanical Garden
C067



Garden Topiary
C024



Cypress
C008



Dusty Olive
C048



Gris Hielo
C007



Glacier Gray
CO52



Gray Violet
CO37



Gris Melange
CO15



Night Owl
CO47



Ebony
CO29



Black
CO02

Vintage



Cannoli Cream
CO42



String
CO38



Cocoa Brown
C1



Black Coffee
CO30



Mostaza
CO18



Nocturne
CO34



Burgundy
C142



Cameo Brown
CO35



Faded Rose
CO12



Baroque Rose
CO68



Potpourri
CO14



Dawn Pink
CO63



Purple Rose
CO33



Maritime Blue
CO04



Marino
CO23



Pageant Blue
CO44



Dark Denim
CO45



Citadel
CO17



Glacier Lake
CO13



Verde acqua
CO20



Deep Teal
CO26



Garden Topiary
CO24



Deep Lichen Green
CO60



Glaciar Gray
CO52



Gray Violet
CO37



Black Oyster
CO11



Ebony
CO29



Black
CO02

Colour equivalences / Equivalencias de color SS24

Colour name	Code	Pantone TCX	CMYK	RGB
Baroque	CO68	18-1634 TCX	23-71-44-13	170-90-102
Black Coffee	CO30	19-1111 TCX	59-62-56-68	60-48-47
Black Oyster	CO11	19-0205 TCX	67-57-52-55	65-65-67
Blue Lolite	CO28	19-4056 TCX	96-72-16-3	26-76-139
Botanical Garden	CO67	19-5220 TCX	87-47-62-57	18-64-60
Brown Rice	CO27	13-1105 TCX	24-22-36-4	200-188-165
Burgundy	C142	19-1617 TCX	41-78-46-52	100-49-62
Cabernet	CO36	19-1724 TCX	63-30-48-12	100-36-46
Cameo Brown	CO35	16-1516 TCX	21-48-42-9	192-138-128
Candy Pink	CO16	14-1911 TCX	0-41-14-0	245-176-189
Cannoli Cream	CO42	11-4302 TCX	7-4-14-0	241-240-226
Chambray Blue	CO66	15-4030 TCX	43-24-8-0	158-180-211
Citadel	CO17	17-4111 TCX	57-35-31-12	116-137-149
Cocoa Brown	C1	18-1222 TCX	40-55-59-48	108-80-66
Coconut Milk	CO03	11-0608 TCX	7-6-11-0	241-238-230
Cypress	CO08	18-0322 TCX	62-45-73-41	84-90-62
Dark Denim	CO45	19-4118 TCX	83-65-40-33	54-70-94
Dawn Pink	CO63	15-2205 TCX	27-38-22-4	191-163-175
Deep Lichen Green	CO60	18-0312 TCX	53-41-57-31	110-110-92
Deep Teal	CO26	19-4914 TCX	87-50-51-49	25-69-75
Double Cream	CO65	12-0715 TCX	7-11-40-0	243-224-172
Dusty Olive	CO48	18-0515 TCX	55-44-56-37	100-99-86
Dusty Rose	CO53	17-1718 TCX	23-57-38-11	186-121-125
Ebony	CO29	19-4104 TCX	70-60-48-49	65-66-74
Eden	CO39	19-6050 TCX	83-43-79-46	38-78-54
Faded Rose	CO12	18-1629 TCX	20-68-51-9	191-100-100

Colour name	Code	Pantone TCX	CMYK	RGB
Fiery Tale	CO64	13-2802 TCX	3-33-7-0	242-193-209
Fiery Red	CO40	18-1664 TCX	11-98-93-2	208-28-31
Fog	CO43	13-0607 TCX	21-20-31-3	208-197-177
Garden Topiary	CO24	18-5913 TCX	71-46-58-45	63-82-75
Glacier Gray	CO52	14-4102 TCX	26-19-19-2	197-198-199
Glacier Lake	CO13	16-4118 TCX	54-29-18-3	129-160-186
Gray Violet	CO37	14-4103 TCX	30-22-23-3	187-188-188
Gris Hielo	CO07	12-4306 TCX	16-9-12-0	221-224-223
Iceberg Green	CO51	16-5808 TCX	48-27-40-9	140-156-146
Lapis Blue	CO25	19-4045 TCX	99-72-14-2	0-76-142
Maritime Blue	CO04	19-3831 TCX	88-78-46-55	39-41-61
Mars Red	CO10	18-1655 TCX	18-95-78-9	188-39-50
Mostaza	CO18	15-1142 TCX	17-37-73-5	209-160-84
Night Owl	CO47	18-4017 TCX	53-42-37-21	121-121-127
Nocturne	CO34	18-1614 TCX	40-68-43-37	123-75-86
Pageant Blue	CO44	19-4111 TCX	94-78-45-50	31-44-67
Potpourri	CO14	13-2004 TCX	10-25-16-0	231-201-202
Purple Rose	CO33	15-3716 TCX	36-40-3-0	176-159-202
Reflecting Pond	CO46	19-4326 TCX	88-59-48-49	32-62-74
Royal Blue	C135	19-3955 TCX	89-81-9-1	62-66-139
Shell Pink	CO69	16-1632 TCX	0-62-39-0	248-129-128
Soothing Sea	CO70	12-5209 TCX	28-0-15-0	195-233-228
String	CO38	16-1305 TCX	33-31-35-11	170-159-150
Summer Sand	CO41	11-0615 TCX	6-6-30-0	243-234-195
Verde Acqua	CO20	14-5413 TCX	53-3-35-0	129-195-180
Verde Botella	CO22	19-5220 TCX	87-47-62-57	18-64-60



OLTEx
t r a d i n g

50% Oltex / 50% Trading
    

Una base de calidad y diseño que
te permite expresar, customizar y
dar vida a tus ideas.

A quality and design base which
allows you to express, customize
and make your ideas come true.

MADE IN SPAIN

www.oltextrading.com